

The Asian Conference on Sustainability, Energy & the Environment 2018  
Official Conference Proceedings  
ISSN: 2186 - 2311

# SURVIVING & THRIVING

Art Center Kobe, Kobe, Japan | June 08–10, 2018

Organised by IAFOR in association with the IAFOR Research Centre at Osaka University and IAFOR's Global University Partners





“To Open Minds, To Educate Intelligence, To Inform Decisions”

The International Academic Forum provides new perspectives to the thought-leaders and decision-makers of today and tomorrow by offering constructive environments for dialogue and interchange at the intersections of nation, culture, and discipline. Headquartered in Nagoya, Japan, and registered as a Non-Profit Organization (一般社団法人), IAFOR is an independent think tank committed to the deeper understanding of contemporary geo-political transformation, particularly in the Asia Pacific Region.

INTERNATIONAL

INTERCULTURAL

INTERDISCIPLINARY

**iafor**



## The Executive Council of the International Advisory Board

**Mr Mitsumasa Aoyama**

Director, The Yufuku Gallery, Tokyo, Japan

**Lord Charles Bruce**

Lord Lieutenant of Fife  
Chairman of the Patrons of the National Galleries of Scotland  
Trustee of the Historic Scotland Foundation, UK

**Professor Donald E. Hall**

Herbert J. and Ann L. Siegel Dean  
Lehigh University, USA  
Former Jackson Distinguished Professor of English and Chair of the Department of English

**Professor Arthur Stockwin**

Founding Director of the Nissan Institute for Japanese Studies & Emeritus Professor  
The University of Oxford UK

**Professor Chung-Ying Cheng**

Professor of Philosophy, University of Hawai'i at Manoa, USA  
Editor-in-Chief, The Journal of Chinese Philosophy

**Professor Steve Cornwell**

Professor of English and Interdisciplinary Studies,  
Osaka Jogakuin University, Osaka, Japan  
Osaka Local Conference Chair

**Professor A. Robert Lee**

Former Professor of English at Nihon University, Tokyo from 1997 to 2011, previously long taught at the University of Kent at Canterbury, UK

**Professor Dexter Da Silva**

Professor of Educational Psychology, Keisen University, Tokyo, Japan

**Professor Georges Depeyrot**

Professor and Director of Research & Member of the Board of Trustees  
French National Center for Scientific Research (CNRS) & L'Ecole Normale Supérieure, Paris, France

**Professor Johannes Moenius**

William R. and S. Sue Johnson Endowed Chair of Spatial Economic Analysis and Regional Planning  
The University of Redlands School of Business, USA

**Professor June Henton**

Dean, College of Human Sciences, Auburn University, USA

**Professor Michael Hudson**

President of The Institute for the Study of Long-Term Economic Trends (ISLET)  
Distinguished Research Professor of Economics, The University of Missouri, Kansas City

**Professor Koichi Iwabuchi**

Professor of Media and Cultural Studies & Director of the Monash Asia Institute, Monash University, Australia

**Professor Sue Jackson**

Professor of Lifelong Learning and Gender & Pro-Vice Master of Teaching and Learning, Birkbeck, University of London, UK

**Professor Sir Geoffrey Lloyd**

Senior Scholar in Residence, The Needham Research Institute, Cambridge, UK  
Fellow and Former Master, Darwin College, University of Cambridge  
Fellow of the British Academy

**Professor Keith Miller**

Orthwein Endowed Professor for Lifelong Learning in the Science, University of Missouri-St. Louis, USA

**Professor Kuniko Miyanaga**

Director, Human Potential Institute, Japan  
Fellow, Reischauer Institute, Harvard University, USA

**Professor Dennis McInerney**

Chair Professor of Educational Psychology and Co-Director of the Assessment Research Centre  
The Hong Kong Institute of Education, Hong Kong SAR

**Professor Brian Daizen Victoria**

Professor of English  
Fellow of the Oxford Centre for Buddhist Studies

**Professor Michiko Nakano**

Professor of English & Director of the Distance Learning Center, Waseda University, Tokyo, Japan

**Professor Thomas Brian Mooney**

Professor of Philosophy  
Head of School of Creative Arts and Humanities  
Professor of Philosophy and Head of School of Creative Arts and Humanities, Charles Darwin University, Australia

**Professor Baden Offord**

Professor of Cultural Studies and Human Rights & Co-Director of the Centre for Peace and Social Justice  
Southern Cross University, Australia

**Professor Frank S. Ravitch**

Professor of Law & Walter H. Stowers Chair in Law and Religion, Michigan State University College of Law

**Professor Richard Roth**

Senior Associate Dean, Medill School of Journalism, Northwestern University, Qatar

**Professor Monty P. Satiadarma**

Clinical Psychologist and Lecturer in Psychology & Former Dean of the Department of Psychology and Rector of the University, Tarumanagara University, Indonesia

**Mr Mohamed Salaheen**

Director, The United Nations World Food Programme, Japan & Korea

**Mr Lowell Sheppard**

Asia Pacific Director, HOPE International Development Agency, Canada/Japan

**His Excellency Dr Drago Stambuk**

Croatian Ambassador to Brazil, Brazil

**Professor Mary Stuart**

Vice-Chancellor, The University of Lincoln, UK

**Professor Gary Swanson**

Distinguished Journalist-in-Residence & Mildred S. Hansen Endowed Chair, The University of Northern Colorado, USA

**Professor Jiro Takai**

Secretary General of the Asian Association for Social Psychology & Professor of Social Psychology  
Graduate School of Education and Human Development, Nagoya University, Japan

**Professor Svetlana Ter Minasova**

President of the Faculty of Foreign Languages and Area Studies, Lomonosov Moscow State University

**Professor Yozo Yokota**

Director of the Center for Human Rights Affairs, Japan  
Former UN Special Rapporteur on Myanmar

**Professor Kensaku Yoshida**

Professor of English & Director of the Center for the Teaching of Foreign Languages in General Education, Sophia University, Tokyo, Japan



The Asian Conference on Sustainability, Energy & the Environment 2018

Official Conference Proceedings

ISSN: 2186-2311



© The International Academic Forum 2018  
The International Academic Forum (IAFOR)  
Sakae 1-16-26-201  
Naka Ward, Nagoya, Aichi  
Japan 460-0008  
[www.iafor.org](http://www.iafor.org)





## Table of Contents

<i>Farmers' Perceptions about Climate Change in the Upper East Region of Ghana</i> Abdul-Razak Zakaria Kenichi Matsui	pp. 1 - 7
<i>Improved Hybrid Biological Reactor Design Under Mixed-Growth Conditions</i> Mohd Elmuntasir Ahmed Rashed Al-Yaseen	pp. 9 - 18
<i>Analysis on Patent Intelligence of Solar Energy Technology in China in the Aspect of Global Competition</i> Li Yang Cui Xiao Liao Qingyun Liu Changxin	pp. 19 - 30
<i>Evaluation of Social Sustainability in Building Projects: Theoretical Framework and Impact Assessment Approach</i> Siyu Liu Shunzhi Qian	pp. 31 - 48
<i>Recycle of Semarang City Liquid Waste With "Reuse" Consortium of Mangrove Probiotic Bacteria Treatment</i> Delianis Pringgenies Rini Widiyadmi Ragil Susilowati Azahra Aliyyu Denaldo Muhamad Afwan Shadri Viharyo Dafit Ariyanto	pp. 49 - 57
<i>Investigating State of the Sustainable Building Design Parameters</i> Reihaneh Aram Halil Z. Alibaba	pp. 59 - 72
<i>Research on Photovoltaic Power Generations Installed in Veranda of Apartment Houses</i> Keiju Matsui Eiji Oishi Mikio Yasubayashi Masayoshi Umeno Masaru Hasegawa	pp. 73 - 84
<i>Energy and Development Discourse in Cambodia: Gaps between Energy Infrastructure for Industrial Development and the Energy Needs of People</i> Maureen Boyle	pp. 85 - 98
<i>Cultural Sustainability of India: A Survival Story</i> Rupa Singh	pp. 99 - 109

- Recent Developments in Russia-Japan Energy Relations*  
Svetlana Vassiliouk pp. 111 - 125
- Desirable Specification of Vetiver Grass Roofing Making Machine*  
Kridsada Saisang  
Krawee Treamnuk  
Tawarat Treamnuk pp. 127 - 138
- Influence of Intake Air Temperature on Performance of Small Gasoline Engine*  
Tawarat Treamnuk  
Krawee Treamnuk  
Sakkarin Papakae pp. 139 - 147
- Kala Cotton: A Sustainable Alternative*  
Banhi Jha pp. 149 - 159
- Theoretical BIM Framework to Sustain the 20th Century Educational Heritage  
in Bangkok: PNRU Buildings*  
Waranyoo Siriwan  
Kitikorn Makaluk  
Pornsiri Teerajak pp. 161 - 174

***Farmers' Perceptions about Climate Change in the Upper East Region of Ghana***

Abdul-Razak Zakaria, University of Tsukuba, Japan  
Kenichi Matsui, University of Tsukuba, Japan

The Asian Conference on Sustainability, Energy & the Environment 2018  
Official Conference Proceedings

**Abstract**

This paper assesses smallholder rice farmers' perceptions about climate change in the Upper East Region of Ghana. We used a pretested questionnaire to understand farmers' perceptions about climate change hazards from fifteen communities in the eastern corridor of the region. We also used ten-year observed climate data (2005-2014) to corroborate farmers' perceptions about climate change. Results from field survey shows that more than 60% of the respondents experienced increasing temperature, decreasing rainfall and changing planting time. The Mann-Kendall trend and Sen's slope test revealed a decreasing rainfall and increasing temperature trend. Farmers' perceived changing planting time is explained by a high coefficient of variation of 28%. The respondents demonstrated high level of awareness, knowledge and understanding about climate change hazards. We argue that farmers' perceptions and experiences about climate hazards can be used where climate data is not available. They can also supplement the recorded climate data.

Keywords: Climate change, farmers' perceptions, rainfall and temperature pattern

**iafor**

The International Academic Forum  
[www.iafor.org](http://www.iafor.org)

## 1. Introduction

Scholars have growingly recognized the importance of local farmers' climate observation in better understanding climate change. The IPCC regional report, for example, highlights shows its increasing recognition of local farmers' observations about climate change as supplement to the scientifically recorded climate data (IPCC, 2014). A growing number of studies have been published regarding farmers' self-assessment of risk associated with climate change hazards as a key in improving climate change adaptation (Niang et al., 2014; Ayanlade et al., 2017; IPCC, 2014). This paper aims to better understand the extent to which the perceptions of smallholder rice farmers about climate change hazards can be reliable in the Upper East Region of Ghana. In doing so, we interviewed farmers and corroborated their observation with the recorded weather information. We also tried to find out if education background can be a factor to influence farmers' ability to accurately observe weather conditions. In the discussion below, we first introduce our study area, the Bawku zone, in the Upper East Region. Then we explain our methodology and results of our survey and analysis.

## 2. Study area

The study area we chose is called the Bawku zone. In 2010, it had the total population of 441,828 people. It is predominantly agricultural region. In 2010 Bawku East district (Bawku Municipality) was most urbanized within the zone with 63% of the population lived in urban areas and about 50% engaged in agriculture. In other districts of the zone, more than 80% of the population engaged in agriculture. In rural areas, nearly all households (98%) were engaged in crop farming (Ghana Statistical Service, 2014).

The Bawku zone has a unimodal rainfall pattern. The mean annual rainfall ranges from 950 mm to 1100 mm. The maximum day temperature can reach as high as 42°C in February and March with night temperatures as low as 18°C. The wet season usually extends from May to October. Rice farming is one of main crops in this region during the wet season. It mainly is rain-fed. Irrigated farming practiced near Tono and Veve dams. The average farm size is estimated at 1.3 hectares with the average yield of 1.8 t/ha. This yield is lower than the national average, which is 2 t/ha. Farmers here use simple implements such as hoe, cutlass, bullock ploughs and sickle (Kranjac-Berisavljevic et al., 2003).

## 3. Methodology

### 3.1 Sampling

In order to assess farmers' perceptions for our survey, we selected five districts from the thirteen administrative districts in the Region. These districts are Bawku East, Bawku West, Binduri, Garu-Tempene and Pusiga. The selected districts have similar characteristics in terms of the climate, soil type, farming system, culture, language and the crops grown (Ghana Statistical Service, 2014). Three communities were selected in each district. The simple random sampling procedure was used in selecting ten farmers from each community. In total, 150 farmers were surveyed.

A preliminary research was carried out to make sure that we clearly communicate with the respondents through the questionnaire. The lead author also spent 10 years in this Region as an agricultural extension officer for the Ministry of Food and Agriculture. We used his work experience in designing the questionnaire, and better interpreting the results.

### 3.2 Data

We conducted a field survey between July and August 2016. The first part of the questionnaire was designed to gather data on socio-demographic characteristics such as farmers' age, gender, education level, and years of experience in rice farming. The second part of the questionnaire aimed to understand rice farmers' perceptions about long-term temperature and rainfall pattern and changes in the past ten years (2005-2014). Then, we gathered observed rainfall and temperature data from 2005 to 2014 in the study area from the Manga Savanna Agricultural Research Institute (SARI-Manga). This data was analyzed to corroborate with farmers' perceptions about climate change.

## 4. Results and Discussion

### 4.1 Socio-demographic characteristics of the respondents

Table 1 shows the socio-demographic characteristics of the respondents in the study area. Regarding age, 87% of the respondents were within 20-59 years of age. Males consisted of 64%. This male dominance was partly because men tend to represent households in answering questionnaires or other requests from outsiders. In our preliminary field survey and Zakaria's working experience in this area, women were dominant in rice farming. In terms of education, more than 80% of the respondents had no formal education or non-formal education. Almost 70% of the respondents had more than 11 years of rice farming experience.

Table 1 Socio-demographic characteristics

Social characteristics	Category	Frequency (%)
Age	20-29	10 (7%)
	30-39	33 (22%)
	40-49	59 (39%)
	50-59	28 (19%)
	60 & above	20 (13%)
Gender	Female	54 (36%)
	Male	96 (64%)
Education	Junior high	15 (10%)
	Senior high	4 (3%)
	Tertiary	7 (5%)
	Non-formal	3 (2%)
	No education	121 (80%)
Years of rice farming experience	1- 10	47 (31%)
	11- 20	59 (39%)

21- 30	30 (20%)
31- 40	9 (6%)
41-50	4 (3%)
51- 60+	1 (1%)

#### 4.2 Farmers' perceptions about climate change

To understand farmers' perceptions about climate change, the respondents were asked about long-term changes in temperature and rainfall patterns in the past ten years (2005-2014). More than 60% of the respondents stated that temperature and drought events have increased, whereas rainfall has decreased. Due to these changes, they had changed planting time (Table 2). The most pronounced effects were decreasing rainfall (84%) and changing planting time (82%) (Figure 1). Climate change is likely having a significant impact on the livelihood of smallholder rice farmers in all five districts of the Bawku zone as 98% of the respondents perceived declining rice yields.

To validate farmers' perceptions that planting time has changed, we calculated and examined ten-year coefficient of variation on recorded annual rainfall from 2005 to 2014. The result was 27.6% (Tables 5). The observed variations in the decadal coefficient of variation mean that annual rainfall in the Bawku zone have varied from the normal by about 28%. Generally, the planting time in this study area starts from May and ends in October (Ghana Statistical Service, 2014).

Having these results, we then tried to find out the extent to which these farmers' perceptions about climate change corresponded with actual observed data in the study area. Results showed that the lowest and highest annual rainfall between 2005 and 2014 are 671 mm and 1562 mm, respectively. The Mann-Kendall's p-value of 0.048 (Table 3) and the Sen's slope value of -44.5 signifies a decreasing trend in annual rainfall in the Bawku zone. This finding suggests that rainfall had varied and decreased by 44.5% in the past ten years. Similarly, the highest and lowest temperature are 37 °C and 20.5 °C, respectively. The Mann-Kendall's p-value for the maximum temperature of 0.251 and that for minimum temperature of 0.917 (Table 4) signifies no trend in the data set. However, the Sen's slope showed maximum temperature increased by 7.8% and that for minimum temperature data decreased by 7.2%.

The results of this study also positively correspond with previous studies on West African sub-regions. These studies reported about increasing temperature and decreasing rainfall (Fosu-Mensah et al., 2012; Zampaligré et al., 2014).

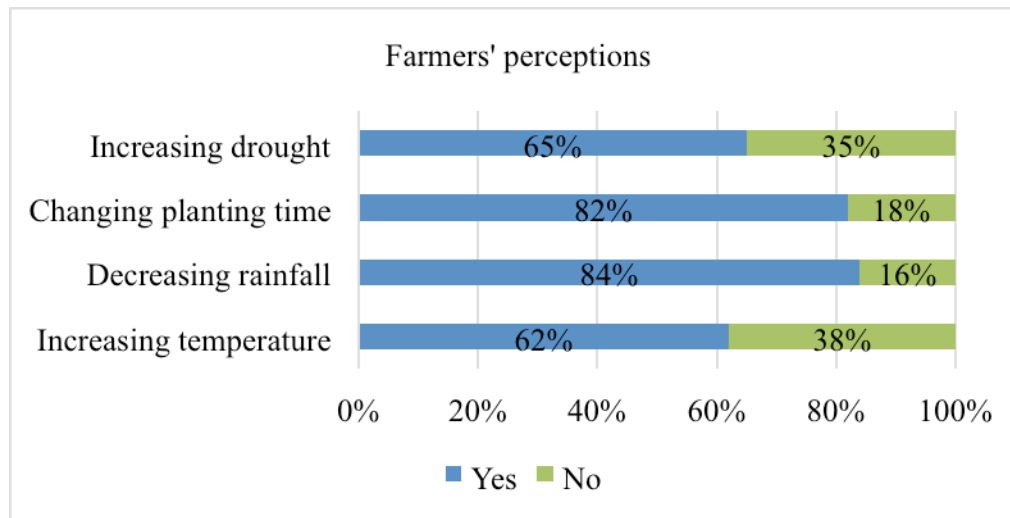

Figure 1 Farmers' perceptions about climate change hazards

Table 2 Chi-squared (p-value) for socio-demographic characteristics and farmers' perceptions

Socio-demographics	Increasing temperature	Decreasing rainfall	Changes in planting time	Increasing drought	Reduced crop yield
Age	0.175 (0.996)	4.695 (0.32)	2.782 (0.595)	4.350 (0.361)	5.773 (0.217)
Gender	2.465 (0.116)	0.028 (0.867)	1.450 (0.228)	5.038 (*0.025)	0.009 (0.923)
Experience	2.916 (0.713)	10.044 (0.74)	5.665 (0.340)	5.212 (0.391)	2.982 (0.703)

$\chi^2$  denotes Chi-squared, df denotes degree of freedom and \* denotes p-value

Table 3 Result of Mann-Kendall trend test for annual rainfall

Kendall's tau	-0.556
S	-20.000
Var(S)	92.000
p-value (Two-tailed)	0.048
Alpha	0.05

Table 4 Result of Mann-Kendall trend test for maximum and minimum temperature

Kendall's tau	0.333	Kendall's tau	-0.056
S	12.000	S	-2.000
Var(S)	92.000	Var(S)	92.000
p-value (Two-tailed)	0.251	p-value (Two-tailed)	0.917
Alpha	0.05	alpha	0.05

## **5. Conclusion**

This paper assessed smallholder rice farmers' perceptions about climate change hazards in the Upper East Region of Ghana. Most responding smallholder rice farmers perceived decreasing rainfall, increasing temperature, and reduced crop yields. They had dealt with these changes by adjusting planting time. Our respondents' perceptions positively corresponded with recorded rainfall and temperature trends with a high coefficient of variation.

Although most of the respondents did not have proper scientific education at formal schools, they demonstrated fairly good awareness and knowledge about climate change phenomena. Their awareness can positively facilitate high adoption of appropriate climate change adaptation strategies in the area. Farmers' perceptions can be relied upon to supplement missing or insufficient meteorological data at the local level to inform agricultural policy.

## **Acknowledgements**

We are grateful to one hundred and fifty farmers in the Bawku zone for their time and cooperation during our questionnaire administration.



## References

- Ayanlade, A., Radeny, M., & Morton, J. F. (2017). Comparing smallholder farmers' perception of climate change with meteorological data: A case study from southwestern Nigeria. *Weather and Climate Extremes*, 15, 24–33.  
<https://doi.org/10.1016/j.wace.2016.12.001>
- Fosu-Mensah, B. Y., Vlek, P. L. G., & MacCarthy, D. S. (2012). Farmers' perception and adaptation to climate change: a case study of Sekyedumase district in Ghana. *Environment, Development and Sustainability*, 14 (4), 495–505.  
<https://doi.org/10.1007/s10668-012-9339-7>
- Ghana Statistical Service-Bawku Municipality, (2014). District Analytical Report – Bawku Municipality. Population and Housing Census, 1–71. Retrieved from [http://www.statsghana.gov.gh/docfiles/2010\\_District\\_Report/UpperEast/BawkuMunicipality.pdf](http://www.statsghana.gov.gh/docfiles/2010_District_Report/UpperEast/BawkuMunicipality.pdf)
- Intergovernmental Panel on Climate Change, IPCC. (2014). Climate Change 2014 – Impacts, Adaptation and Vulnerability: Part B: Regional Aspects: Working Group II Contribution to the IPCC Fifth Assessment Report. Cambridge: Cambridge University Press. doi:10.1017/CBO9781107415386
- Kendall, M. G. (1975). Rank correlation method, 4th edn. Charles Griffin, London.
- Kranjac-Berisavljevic, G., Blench, R. M. & Chapman, R. (2003). Multi-Agency Partnerships (Maps) for Technical Change in West African Agriculture: Rice Production and Livelihoods in Ghana ODI/UDS.
- Niang, I., Ruppel, O. C., Abdrabo, M. A., Essel A., Lennard C., Padgham J. & Urquhart P., (2014). Africa. Chapter 22. In: *Climate Change 2014: Impacts, Adaptation, and Vulnerability. Part B: Regional Aspects. Contribution of Working Group II to the Fifth Assessment Report of the intergovernmental Panel on Climate Change*, edited by Barros, V.R., et al. (eds.)). Cambridge, UK, and New York, USA: Cambridge University Press, pp. 1199-1265.
- Nkrumah, F., Ama, N., Klutse, B., Adukpo, D. C., Owusu, K. & Quagraine, K. A. (2014). Rainfall Variability over Ghana: Model versus Rain Gauge Observation, 673–683.
- Sen, P.K., (1968). Estimates of the regression coefficient based on Kendall's tau. *Journal of the American Statistical Association*, 63, 1379–1389.
- Zampaligré, N., Dossa, L. H., & Schlecht, E. (2014). Climate change and variability: Perception and adaptation strategies of pastoralists and agro-pastoralists across different zones of Burkina Faso. *Regional Environmental Change*, 14 (2), 769–783.  
<https://doi.org/10.1007/s10113-013-0532-5>



## ***Improved Hybrid Biological Reactor Design Under Mixed-Growth Conditions***

Mohd Elmuntasir Ahmed, Kuwait Institute for Scientific Research, Kuwait  
Rashed Al-Yaseen, Kuwait Institute for Scientific Research, Kuwait

The Asian Conference on Sustainability, Energy & the Environment 2018  
Official Conference Proceedings

### **Abstract**

Wastewater treatment and disposal is a pillar for safeguarding public health and sustaining socioeconomic development. The cost and design efficiency of various wastewater treatment technologies are key factors in the economic value of treated wastewater. However, biological treatment processes are among the most valuable among a vast array of treatment technologies. Biological reactors conventional design procedures are normally sufficient to achieve desired treatment efficiencies while assuming suspended-growth only and attached growth only. The ASP and RBC are typical examples. This assumption of one dominant state of microorganisms has come under increased scrutiny in recent years due to advances in biological processes. For instance, in a fluidized bed biofilm reactor or an integrated film activated sludge reactor, high fluid shear can dislodge attached cells in high quantity and increases the amount of suspended cells. These biofilm reactor, intended by design, may actually be operating like a suspended growth reactor. As such, these reactors have become a bona fide “hybrid” biological reactors. In hybrid biofilm reactors neither suspended nor biofilm kinetics are dominant. Procedures incorporating both suspended and attached growth kinetics must be used. This paper addresses possible improvement in the design procedure for hybrid reactors using a mathematical model and preliminary results of experimental testing of a hybrid reactor using petrochemical wastewater. The model takes into consideration parameters which were not considered in conventional design procedures such as biofilm diffusional resistance, suspended versus attached microorganisms substrate utilization ratio (biomass ratio in conventional design procedures), hydraulic retention time, and shear loss.

Keywords: wastewater treatment, industrial wastewater, hybrid biological reactors, mixed growth biological processes, kinetic modeling

**iafor**

The International Academic Forum  
[www.iafor.org](http://www.iafor.org)

## Introduction

In most biological reactors conventional design procedures are normally sufficient to do a good job. The activated sludge process (ASP) and the rotating biological contactor (RBC are) examples of the suspended-growth and attached growth (Metcalf and Eddy, 2014). However, in innovative biological reactors neither suspended nor biofilm kinetics is sufficient (Chang et al., 2005; Rittman and McCarty, 2001). Hybrid model incorporating both suspended and attached growth kinetics must be used including provision for shear losses.

The conventional approach for the design of biological reactors assumes that microorganisms either in a suspended or attached state, but not both, are responsible for the utilization of organic substrate (Metcalf and Eddy, 2014; Sarkar and Mazumdar, 2015). This approach works well for conventional biological reactors, which strongly favor suspended or attached biomass. For example, an activated sludge process has a large aeration basin containing cells in suspension for the degradation of organic compounds. Although attached cells, or biofilm, exist on basin wall and diffusers, they are in small amounts and contribute very little to the degradation of organic substrate.

The assumption of one dominant state of microorganisms has come under increased scrutiny in recent years due to advances in biological processes (Sarkar and Mazumdar, 2015; Metcalf and Eddy, 2014). For instance, in a fluidized bed biofilm reactor high fluid shear can dislodge attached cells in high quantity and increases the amount of suspended cells and, in this case, the biofilm reactor, intended by design, may actually be operating like a suspended growth reactor. Another example is the modification of the activated process to cope with an increasing organic loading arising from population growth. Packing materials for biofilm growth have been added to existing aeration basins to increase the total biomass in the basins. As a result, these reactors have become a bona fide “hybrid” biological reactors.

Hybrid bioreactor having both suspended-growth and attached-growth bacteria is found a novel and excellent bioreactor system for treating the municipal wastewater containing inhibitory substrates too. In this reactor a fraction of substrate is used by suspended biomass and the remaining by attached biomass resulting in the competition between the two growths for the substrate. The combination of suspended and attached growth provides the system with enhanced biomass concentration and sludge age more than those in ASP. Similar to attached growth system, the hybrid bioreactor ensures considerable efficiency for treating toxic and refractory substances in wastewater (Sarkar and Mazumdar, 2015).

In hybrid reactors usually two questions are raised: Are suspended cells, attached cells, or both, dominating the removal of substrate in biological reactor? What is the design procedure for a hybrid biological reactor? For the process design of hybrid bioreactor a suitable mathematical model is required. Although various mathematical models were developed on hybrid bioreactor in due course of time in earlier research works, none of them was found having a specific implied solution of the corresponding models and

without having any drawback. To overcome this drawback a mathematical model for process design of a hybrid bioreactor needs to be developed.

So far, a few numbers of model expressions for the hybrid bioreactor was developed and almost none of them considered the concurrent growth of both suspended and attached biomass except the model proposed by (Chang et al., 2005).

However, the numerical solution obtained by Regular Falsi method (lee, 1992, Sez and Rittman, 1991) in that case was for a chemostat. In other cases, model expression for hybrid bioreactor was developed using either a set of dimensionless algebraic equation (Kim and Suidan, 1989) or some graphical tools (Fouad and Bhargava, 2005), which lead to an approximate solution. However, it also could not provide an accurate solution and ultimately it was difficult to predict the performance of the hybrid bioreactor. Therefore a proper process design for hybrid bioreactor finds its relevance for predicting its performance.

This study addresses these questions by using a mathematical model to quantify the rate of organic degradation by suspended and attached cells co-existing in a “hybrid community.” The system modeled was a completely mixed flow (CMF) reactor containing pure culture microorganisms degrading a single substrate. The utilization of substrate by suspended cells was described by Monod equation (Metcalf and Eddy, 2014); and for attached cells by simultaneous diffusion and degradation equation. The simple CMF system allowed the modeling study to focus on the interplay between suspended and attached cells.

The objectives of this study are first to develop a hybrid model for a completely mixed flow (CMF) reactor, i.e., a chemostat. The model will be used to determine the conditions under which one of the two states, or both, will become responsible for the removal of majority of contaminants. Dominant regions for the cells will be delineated in a multi-dimensional space of process parameters. The selection of a simplistic chemostat model will allow this study to focus on interactions, rather than the effects of hydrodynamics.

The present paper briefly highlights on the various aspects of process design of an aerobic hybrid bioreactor for the treatment of municipal wastewater.

## **Hybrid biological reactors non-steady-state model**

### ***Kinetics of suspended cells***

A schematic diagram of a hybrid biological reactor is shown in Figure 1a. the total volume  $V_T (L^3)$  can be divided into void volume  $V_v (L^3)$  and the volume occupied by the solid material of packing media  $V_s (L^3)$ .

$$V_T = V_s + V_v (= V_s + nV_T) \quad (1)$$

The void volume is where suspended cells can grow and the volume occupied by the packing solid material is not useful for treatment. Biofilm also occupies a small volume, but it is usually negligible when compared to the total volume.

The specific area for the packing media is defined as the total surface area of the packing media divided by the reactor volume  $a = \frac{A}{V_T}$ .

The utilization of substrate by suspended cells can generally be described by the Monod equation. The amount of pollutants removed by suspended cells per day,  $r_s \left( \frac{M_s}{T} \right)$ , can therefore be calculated by the following equation:

$$r_s = \frac{kS_b}{K_s + S_b} X_s V_v \quad (2)$$

Where  $k$  is the maximum specific rate constant for substrate utilization  $\left( \frac{M_s}{M_x \cdot T} \right)$ ;  $K_s$  is the half rate concentration  $\left( \frac{M_s}{L^3} \right)$ ;  $S_b$  is the organic concentration in bulk liquid  $\left( \frac{M_s}{L^3} \right)$ ; and  $X_s$  is the concentration of suspended cells  $\left( \frac{M_x}{L^3} \right)$ .

The concentration of suspended cells in a hybrid reactor changes due to growth from substrate utilization, endogenous decay, shear-off from biofilm, and wash-out in the effluent. These four mechanisms can be described as follows, assuming there are no cells in the influent:

$$\frac{dX_s}{dt} = -\frac{Q}{V_v} X_s + \left( \frac{YkS_b}{K_{s+}S_b} - b \right) X_s + \frac{A}{V_v} b_s L_f X_f \quad (3)$$

Where  $Q$  is the wastewater flow rate  $\left( \frac{L^3}{T} \right)$ ;  $Y$  is the yield  $(T^{-1})$  and  $b$  is the decay  $(T^{-1})$  coefficient for cells;  $b_s$  is the shear loss coefficient for attached cells  $(T^{-1})$ ;  $A$  is the biofilm surface area  $(L^2)$ ;  $L_f$  is the biofilm thickness  $(L)$ ;  $X_f$  is the cell density in biofilm  $\left( \frac{M_x}{L^3} \right)$ ; and  $t$  is the time  $(T)$ . The last term in the equation assumed that sheared-off attached cells become suspended cells.

$\frac{\partial X_s}{\partial t}$  = change in suspended bacteria with time

$\frac{Q}{V_v} * X_s$  = suspended biomass washes out

$\left( \frac{Y * K * S_b}{K_s + S_b} \right) * X_s$  = net rate of growth

$\frac{A}{V_s}$  = shear loss

### Biofilm kinetics

Biofilm is a layer-like aggregate of microorganisms attached on a solid surface. The thickness of the biofilm poses a diffusional resistance to the transport of substrate in the biofilm resulting in concentration profile. The cells near the exterior (i.e. liquid side) “encounter” a higher substrate concentration than those in the interior near the solid wall. The profile of substrate concentration in the biofilm (Figure 1b) can be described by the following diffusion with reaction equation:

$$\frac{\partial S_f}{\partial t} = D_f \frac{\partial^2 S_f}{\partial z^2} - \frac{k S_f}{K_s + S_f} * X_f \quad (4)$$

Where  $S_f$  is the substrate concentration in the biofilm  $\left(\frac{M_s}{L^3}\right)$ ;  $D_f$  is the diffusivity of substrate in the biofilm  $\left(\frac{L^2 T}{L}\right)$ ; and  $z$  is the distance in biofilm  $(L)$ .

$\frac{\partial S_f}{\partial t}$  = Change in substrate concentration within biofilm

$D_f \frac{\partial^2 S_f}{\partial z^2}$  = Diffusion flux term (fick's 2<sup>nd</sup> law of diffusion)

$\frac{K * S_f}{K_s + S_f} X_f$  = Substrate degradation by the attached biomass (Monod reaction or Michellis-Menten model)

Two boundary conditions are required for the above governing equation, one at the exterior ( $z = L_f$ ) and another at the interior ( $z = 0$ ) of the biofilm:

1. Amount of water exist from bulk solution equal to that enter to bio film

$$D_f \frac{dS_f}{dz} = k_f [S_b - S_f]_{z=L_f} \quad \text{at } z = L_f \quad (5)$$

$D_f \frac{\partial S_f}{\partial z}$  = Substrate flux entering the bio film

$K_f [S_b - S_f]$  = Substrate flux leaving the bulk solution

2. The tangent is horizontal at  $z = 0$

$$\frac{\partial S_f}{\partial z} = 0 \quad (6)$$

Where  $k_f$  is the film transfer coefficient across the boundary layer  $\left(\frac{L}{T}\right)$ . Microbial cells in the biofilm grow due to substrate utilization, decay due to death, and can be sheared off by the wastewater flowing in the reactor. Biofilm thickness changes as a result of these mechanisms. Because the substrate concentration varies in the biofilm, the growth rate must be integrated to obtain the time-evolution of biofilm thickness:

$$\frac{dL_f}{dt} = \int_0^{L_f} \left[ \frac{YkS_f}{K_s + S_f} - b - b_s \right] dz$$

(7)

$\frac{\partial L_f}{\partial t}$  = Change in bio film thickness with time

$\frac{Y * K * S_f}{K_s + S_f} - b - b_s$  = Total amount of substrate consumed by the attached microorganism

### **Hybrid reactor model**

The change in substrate concentration in the bulk phase of hybrid chemostat is caused by: 1) Substrate inflow in the influent; 2) Substrate outflow from the effluent; 3) Substrate utilized by suspended cells; and 4) Substrate utilized by the biofilm. The equations for the four mechanisms are assembled as presented in the following equation:

$$\frac{\partial S_b}{\partial t} = \frac{Q}{V_v} (S_o - S_b) - \frac{kS_b}{K_s + S_b} X_s - k_f \frac{A}{V_v} (S_b - S_f|_{z=L_f})$$

(8)

Where  $S_o$  is the substrate concentration in the influent ( $M/L^3$ ). In a chemostat, the substrate concentration in the effluent is the same as that in the reactor. Equation 3 to 8 constitute the nonsteady state model for a hybrid biological reactor in which both suspended and attached cells are responsible for the removal of organic pollutants. The solution to the model yields the time-evolution of substrate concentration, suspended cells concentration, and biofilm thickness.

The nonsteady state hybrid model consists of four governing equations describing the time-evolution of four dependent variables: bulk substrate concentration ( $S_b$ ), substrate concentration in the biofilm ( $S_f$ ), biofilm thickness ( $L_f$ ), and the concentration of suspended cells ( $X_s$ ).

### **Model Solution**

The equations were solved using numerical integration vis Gear's method for stiff systems coded in a subroutine DISODE (Hindmarch, 1980). A FORTRAN program to solve the above differential equation from (2) to (8) was developed.

The program must provided with the some important parameters such as substrate diffusivity in bio film (cm<sup>2</sup>/day), film transfer coefficient (cm/day), max substrate specific utilization rate (1/day), half rate concentration (mg/ml), yield coefficient (mg vss/mg sub), decay coefficient (1/day), shear loss coefficient (1/day), total bio film loss coefficient (1/day) bio film density (mg vss/ml), initial bio film thickness (cm), influent substrate concentration (mg/ml), influent flow rate (ml/day), reactor volume for



suspended growth (ml), surface area for biofilm growth (cm<sup>2</sup>), substrate flux into bio film (mg/day) and substrate utilization by suspended cells (mg/day)

The important parameters are listed in Table 1. It is important to know that some of these parameters were estimated in a previous study (Ahmed et al., 2017), as discussed in section 4.1, and the others are obtained from Chang et al. (2005).

**Table 1. Kinetic Parameters Used in the Model Solution (Ahmed et al., 2017)**

Parameter	Unit	Value
$Y$	1/d	4.59
$1/k$	mg-substrate/mg-VSS/d	0.12
$K_s$	mg/l	20
$b$	1/d	1.61
$b_s$	1/d	0.1
$D_f$	cm <sup>2</sup> /d	0.67
$k_f$	cm/d	250
$X_f$	g-VSS/l	400

VSS: Volatile suspended solids.

## Results and Discussions

Metcalf and eddy (2014) presented solutions for a trickling filter with different types of packing material. For example the general they presented general guidance for selection of suitable type of trickling filter out of which high surface area plastic packing parameters are shown in Table 2.

**Table 2. Trickling filter design parameters for plastic packing treating primary effluent [Metcalf and eddy, 2014]**

Design parameter	Units	Partial BOD removal
<b>BOD removal efficiency</b>	%	40-70
<b>Ventilation</b>	Type	Forced air
<b>Organic loading</b>	Kg. BOD/m <sup>3</sup> .d	1.6-3.5
<b>Hydraulic loading</b>	M <sup>3</sup> /m <sup>3</sup> .d	40-100
<b>Recirculation ratio</b>	QR/Q	0-2
<b>Depth</b>	M	0.9-6
<b>Effluent quality</b>	BOD, mg/l	>30

Additionally, the water environment federation (WEF) (Metcalf and Eddy, 2014) provided empirical solution for high surface area plastic packing media. WEF solution is used as means of illustrating the use of the model developed in this paper and as a

comparison between the experimental results obtained (Ahmed et al., 2017, Ahmed et al., 2018) and the model results. The comparison is shown in Table 3 and Figure 1.

**Table 3. Using the WEF (2011) (Metcalf and Eddy, 2014) formulation for plastic packing to compare with model and experimental results**

Type of wastewater	Flow (ml/min)	So (mg/l)	Se (mg/l)	% Removal	Se WEF (mg/l)	Se Model (mg/l)
Domestic	50	18	8	55	8.5	9
Petrochemical	50	92	38	58	43	39
petrochemical	100	83	39	53	77.5	40

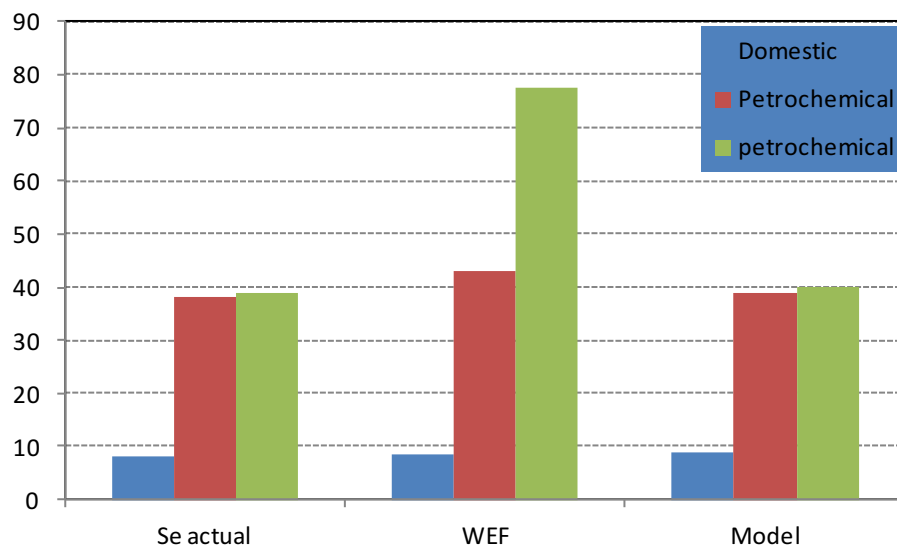

**Figure 1. Comparison of Model vs. WEF Solution.**

It is clear that the model is able to predict the performance in a better way than the WEF solution especially at higher flow rates. Additionally, the model is able to give a better understanding and knowledge of the controlling and limiting steps. The model results indicated that biomass measurement, which has been used alone by previous researchers, is inadequate to determine the dominant microorganisms responsible for substrate utilization (Ahmed et al., 2017). Diffusional resistance in the biofilm can decrease the rate of substrate removed by the biofilm. A thick biofilm with low substrate diffusivity may not degrade a greater amount of substrate than suspended cells.

These results indicate that care must be taken when designing and operating a biological reactor to ensure that cells responsible for the removal of organic substrate are dominant as intended.

## Conclusions

In this paper, model simulations illustrating the flexibility in operation for a hybrid reactor are discussed. Potential benefits which may be exploited in a multi-species hybrid reactor will also be discussed.

The main conclusion of this study is that the conventional design procedure of biofilm reactors has drawbacks which could be overcome by the use of a more detailed mathematical model. The mathematical model is very advantageous in its output than the empirical formulation to study and design biofilm wastewater treatment processes. More specifically:

- The mathematical model can reasonably predict the process performance especially at higher flow rates where, e.g. WEF 2011 formulation, over estimate process parameters.
- The mathematical model help obtaining better estimates for process parameters can be used to scale up the process.

## Acknowledgements

The authors would like to thank Kuwait Foundation for the Advancement of Science (KFAS) and Kuwait Institute for Scientific Research (KISR) for funding the study Project No. WT046C.

## References

- Ahmed M., Mydlarczyk A., and Abusam A. 2017. Kinetic modeling of GAC - IFAS chemostat for petrochemical wastewater treatment. *Journal of Water Resources and Hydraulic Engineering*. 6(2): 27-33.
- Ahmed M., Al-Dhafeeri A., Mydlarczyk A. 2018. Predominance of attached versus suspended growth in a mixed-growth, continuous-flow biological reactor treating primary-treated petrochemical wastewater. *Arabian Journal for Science and Engineering*. Accepted 17 May 2018.
- Chang, H. T., S. J. Parulekar and M. Ahmed. 2005. A dual-growth kinetic model for biological wastewater reactors. *Biotechnology Progress* 21(2):423–31.
- Fouad, M and Bhargava. R 2005. Mathematical model for the biofilm-activated sludge Reactor. *Journal of Environmental Engineering*, 131( 4), pp 557- 562.
- Hindmarsh, A. C. (1980) “LSODE and LSODI, two initial value ordinary differential equation solvers,” ACM-SIGNUM Newsletter, 15(4), 10-11.
- Kim. R. and Suidan. T. 1989. Approximate algebraic solution for a biofilm model with the monod kinetic expression. *Water Research*, 23(12), pp. 1491-1498
- Lee, Chi-Yuan. 1992. Model for Biological Reactors Having Suspended and Attached Growths. *Journal of Environmental Engineering*, 118(6), pp. 982-987.
- Metcalf and Eddy. 2014. *Wastewater Engineering: Treatment and Resource Recovery*. NY: McGraw-Hill.
- Rittman, B., and P. McCarty. 2001. *Environmental Biotechnology: Principles and Applications*. New York: McGraw-Hill Science Engineering.
- Saez. P. and Rittmann. B. 1991. Accurate Pseudo analytical solutions for steady state biofilm. *Biotechnology and Bioengineering*. 39, pp. 790-793.
- Sarkar, S. and Mazumder, D. 2015. Process Design and Application of Aerobic Hybrid Bioreactor in the Treatment of Municipal Wastewater. *International Journal of Chemical and Molecular Engineering*. 9(3), 500-504.

**Contact email:** miahmed@kISR.edu.kw, rayaseen@kISR.edu.kw

***Analysis on Patent Intelligence of Solar Energy Technology in China in the Aspect of Global Competition***

Li Yang, National Science Library, University of Chinese Academy of Sciences, China  
Cui Xiao, CHINALCO Finance Company Limited, China

Liao Qingyun, National Science Library, Chinese Academy of Sciences, China  
Liu Changxin, Institutes of Science and Development, Chinese Academy of Sciences,  
China

The Asian Conference on Sustainability, Energy & the Environment 2018  
Official Conference Proceedings

**Abstract**

Faced with the increasingly fierce international competition, climate change and other global challenges, it is more important for national governments to take the analysis on patent intelligence of solar energy technology one step further. Based on Innography patent information retrieval platform, this paper analyzed the competition pattern and development trend in patents for global solar energy technology from the aspect of patent country, application country, IPC distribution and patent rights. A comparative study was conducted on the technology layout in Chinese market between local technology developers and global technology developers. It is of great interest to discover the competition trends in patents for global solar energy and hot technology layout, on which this paper evaluated from the competitive environment, competitors, competitive technology and international strategy.

Keywords: solar energy technology; patent intelligence; Innography; patent intelligence; core patent; technology layout.

**iafor**

The International Academic Forum  
[www.iafor.org](http://www.iafor.org)

## 1. Introduction

Nowadays, whether a country is at the forefront of energy technology will influence national economy development, which is associated with the potentiality of economic growth, long-term energy security, economic development and technological innovation (Hoppmann, Peters, Schneider, & Hoffmann, 2013). However, carbon-dioxide emission which is related to energy consumption counts the majority of greenhouse-gas emission of human activity and causes a serious impact on climate warming. Fortunately, the development of renewable energy sources has had a crucial influence on the reduction of carbon-dioxide emission and geopolitics problem (Fan, Liu, & Zhu, 2017). The Asian markets headed by Japan, China, and South Korea have also experienced significant growth in recent years because of technological advances and government support (Timilsina, Kurdgelashvili, & Narbel, 2012). "Renewable Energy Directive" published by European commission has greatly promoted the rapid development of renewable energy generation in Europe, especially solar power (Frietsch & Schmoch, 2010). Three technologies among seventeen renewable energy technologies that most potential for carbon dioxide emission reduction announced by the International Energy Agency (IEA) are correlating with solar energy, including solar photovoltaic systems, solar thermal power plants, and solar heating and hot water supply<sup>[6]</sup>. Solar energy technology is one of the core technologies in the field of renewable energy. In order to gain leading advantages in the future energy market, lots of enterprises have participated in solar patents fierce competition under the support of national policies (Zhao, Zhao, Deng, & Zheng, 2015).

In recent years, statistical and comparative methods are used in patent and literature information inspection of solar energy field. Johnstone, Haščič, and Popp (2010) analyzed the patent data from 1978-2003 in 25 countries and concluded that public policy plays an important role in the application of renewable energy patents. Pettersson, Nonumura, Kloo, and Hagfeldt (2012) analyzed the patent application trends of dye-sensitized solar cells and amorphous silicon thin-film solar cells, respectively. Frauke<sup>[11]</sup> study the development of global concentrated solar power technology based on patent data. Tour, Glachant, and Ménière (2011) analyze the superiorities and limitations of China's photovoltaic industry based on international patent data, and particular emphasis the positive influence of technological transformation and innovation. Luan, Liu and Wang (2013) study global solar energy patent measurement and reveal two evolutionary trends of divergence and convergence caused by the linkage changes of solar energy technology. Zhang and Chen (2013) took the length of patent duration as a measure of patent quality, study the quality of patents for R&D units from 1985 to 2009, they find that cooperative research across different units can significantly improve the patent quality of solar energy. In this background, it is of great significance to carry out competitive analysis in global deployment of solar energy technologies, track key technologies, and discovery prospective new technologies. In view of this, this research adopts patent intelligence analysis technology, and the key issues to be solved are: the answer to this key issue will serve as a reference for the development and breakthrough of China's solar patent technology. Hence, we studied global solar energy technology competition pattern and development trend and China's solar energy technology's global competitiveness by data mining technology. This research is critical for the development of solar energy R&D, especially in China.

## 2. Data Retrieval and Collection

Innography is a highly-respected patent retrieval and analysis tool in recent years (Zhang, 2014). It integrates database and information retrieval functions, and its underlying data includes more than 80 million patent data, US patent litigation data, U.S. trademark data, and organizational business data in 90 countries and regions around the world. The platform has its algorithm constructed by a unique scoring system to recognize core patents. For the integrity and independence of data, this study based on EST Concordance patent classification index and solar research features to formulate patent search strategy and the database is Innography platform. Patent search strategy is as follows: ((abstract, claims, title) ("solar energy") or ("solar power") ("suns energy") or ("sun power")) AND (IPC\_F24J002 OR IPC\_H01L031 OR IPC\_F03G006 OR IPC\_H01L031 OR IPC\_F24J002 OR IPC\_F24D017 OR IPC\_F24D003 OR IPC\_F24J002 ) (@\* inno\_utility\_patent). What's more, retrieval time is from January 1, 1910 to May 10, 2017. We retrieved 69,479 patents, including patents for inventions and patents for utility models. It should be noted that the Chinese region in this patent database only refers to mainland China and does not include Hong Kong, Macao, and Taiwan.

## 3. Patent Analysis

### 3.1 Patent application analysis

The current status and scale of global solar technology development can be reflected by the annual applications amount of priority patents and the amount of patent disclosures. Trends in the priority years and public years of 69,479 solar energy patents are shown in Figures 1 and 2<sup>1</sup>.

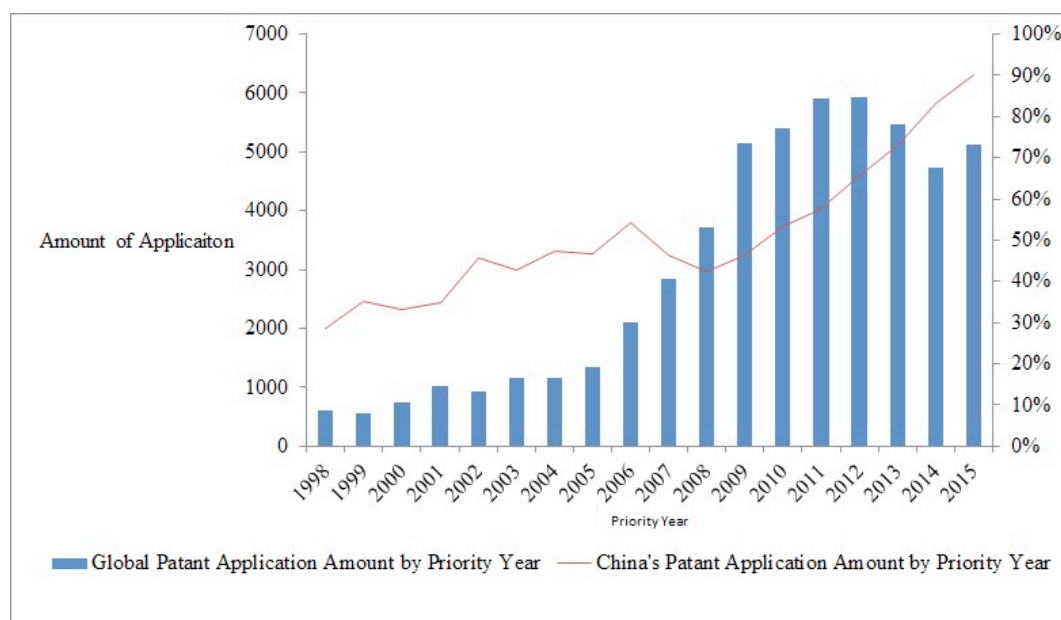

Figure 1. Solar energy patents application by priority year

<sup>1</sup> Before 1998, the number of patent applications in the global solar field was few, therefore, it was not shown in figure 1 and figure 2.

As we can know from figure 1, before 2000 the number of patent applications was few, and the average annual application number was less than 1,000. This period is the introduction period of solar energy technology. In 2001, the number of solar energy patent applications exceeded 1,000 for the first time, except for a slight drop of 918 applications in 2002. After five years of accumulation, the number of patent applications for solar energy exceeded 2,000 in 2006, and the number of patent applications for that year was 2,099, marking that the solar energy technology enters a slow growth period. Under the dual drive of global climate change and low-carbon energy technologies, solar energy technology entered a phase of rapid development in 2007, ushering in an upsurge of application and peaking in 2012. In total, 5,921 patents were filed in 2012. The surge in the number of applications for patents during this period was mainly due to the strong demand for low-carbon energy technologies represented by Europe and the United States under the pressure of global climate change, and countries have been advancing the development of low-carbon energy technologies. In particular, with the pushing of Copenhagen Climate Conference held in 2009, China's solar patent applications have reached the highest historical rate of 39%. However, as countries failed to achieve the global cooperative emission reduction plan for climate change, the growth rate of patent applications for solar energy has slowed down significantly since 2009, and the number of applications has decreased for two consecutive years since 2012. The number of patent applications in 2015 has increased slightly when compared with 2014 but was still lower than 2009. Analysis above shows that the development of global solar energy technology is mainly influenced by the factor of international political environment.

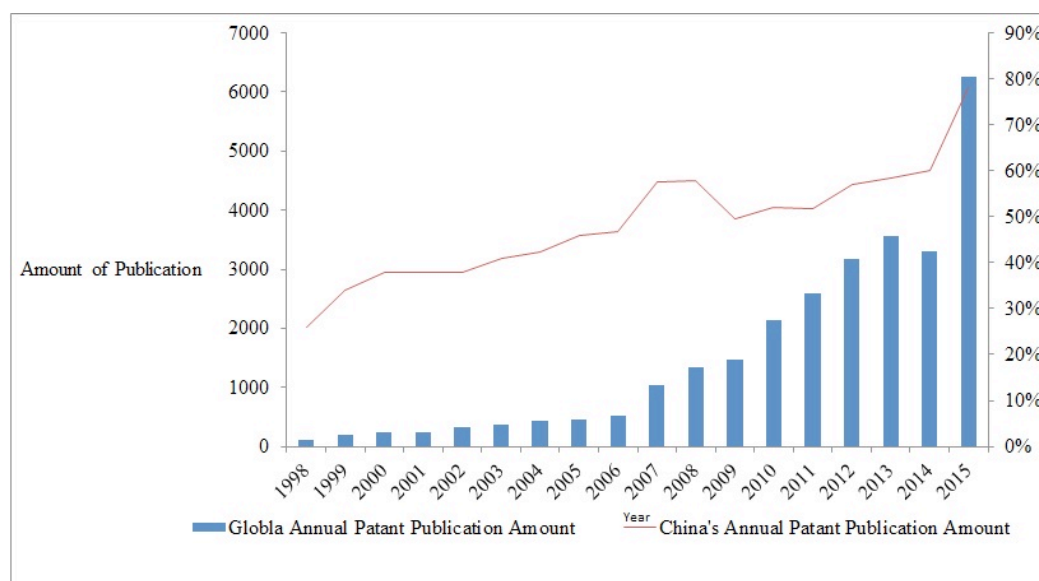

Figure 2. Solar energy patents application by publication year

Figure 2 shows the global solar patent disclosure volume. It can be seen that its overall trend is similar with the trend of priority patent application number. Statistics show that period of 2001-2006 and period of 2007-2015 respectively correspond to the slow growth and rapid development of solar energy technology in the world. For the two phases, there are 2328 and 24,895 solar energy patent disclosures respectively.

Under the driving of global climate change and low-carbon energy demand, Countries are striving to develop solar energy technology and continuously achieve technological



breakthroughs. The Copenhagen Climate Conference effect appeared in 2010, with the number of global solar patents speeding up at a rate of 45%, and the absolute number peaked at 6256 in 2015. It can be predicted that this trend will last for some time and the solar energy industry will boom in the near future.

Whether the number of patent applications for priority applications or the number of annual patent disclosures, the number of Chinese patents has been in a rapid growth, and its proportion of the world has increased year by year. Since the global solar energy technology entered a period of rapid development from 2007, China has accounted for more than 50% of the global solar patent disclosure volume, and the number of applications from 2010 accounted for more than 50%. In 2015, China's patented solar energy technology applications accounted for nearly 90% of the global patents applications. The greatly change due to China's promotion of solar energy industry development policy. Before 2009, the Chinese government mainly adopted financial subsidies to encourage the use of renewable energy such as solar energy to solve the problem of electricity consumption in remote and uncharged areas and promote energy conservation in construction. From 2009 to 2012, the Chinese government promoted solar (photovoltaic) power technology by means of leading projects that combined construction with solar energy. The photovoltaic industry has also been established as a strategic potential industry, which has been included in the key support of national industrial policies. After 2012, the Chinese government strengthened the elimination of photovoltaic power and the development of industrial standards, encouraged the development of distributed power stations and large-scale ground power stations, and increased the proportion of renewable energy such as solar power.

### 3.2 Patent application country analysis

The patent application country analysis can reveal the regional distribution of patent layout. Usually, patent applicants will pay attention to areas that are gathering high input in research and development or potential in commercial application. The statistical results of the solar technology applicant country are shown in Figure 3:

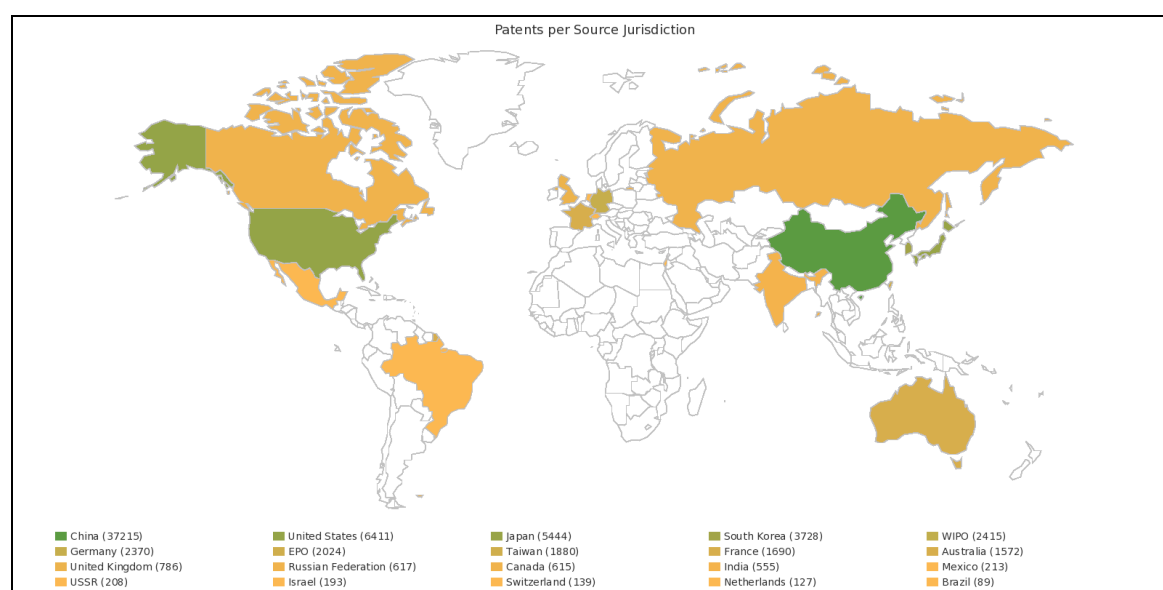

Figure 3. Solar energy patents application countries

Figure 3 shows that China, the United States, Japan, and South Korea are the main countries which have lots of patents. China has the largest number of open patents, a total of 37,215, accounting for 54% of the world's share; the United States followed, with 6411 open patents, accounting for 9%; followed by Japan and South Korea with 5,444 and 3,728 open patents respectively, both accounting over 5%. The above four countries open patent count 52,798 patents, accounting for 76% of global solar energy patents. Therefore, China, the United States, Japan, and South Korea are the main forces in global solar energy technology innovation. In addition, the number of applications from the World Intellectual Property Organization (WIPO), Germany, and the European Patent Office (EPO) is more than 2,000, which indicates that the patent holders are generally optimistic about the prospects of solar energy technology development and are actively conducting global patent distribution to enter the international market.

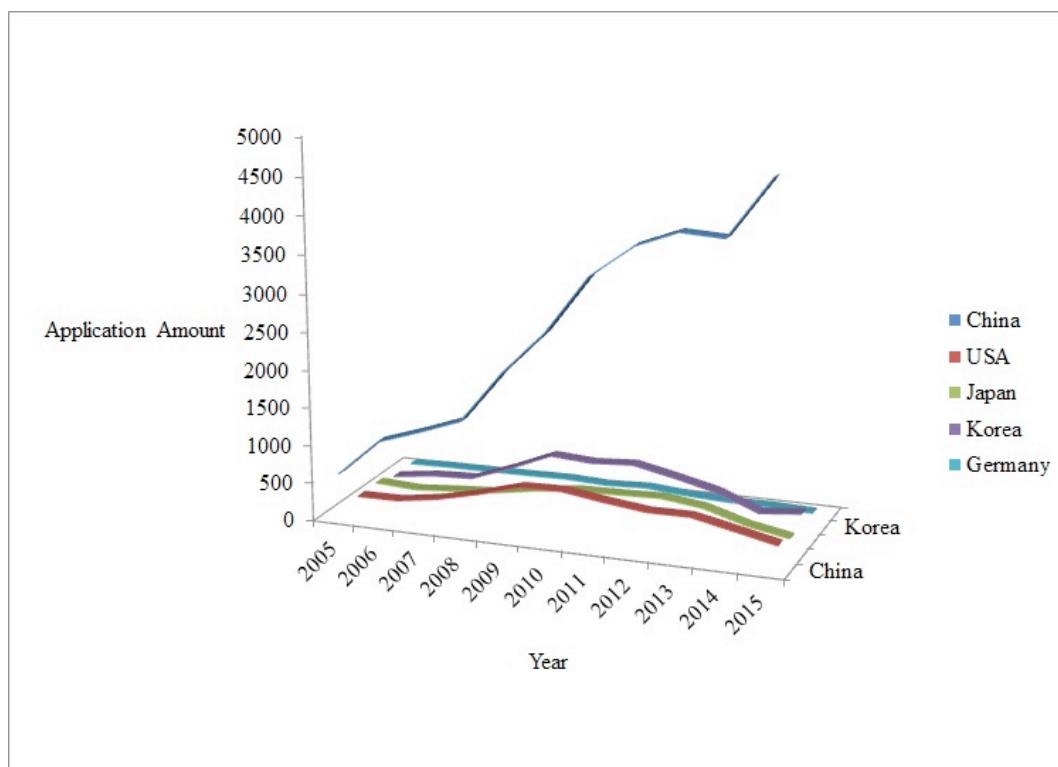

Figure 4. Solar energy patents application number in main application countries during 2005-2015

Figure 4 shows the status of solar patent applications in main countries from 2005 to 2015. Since 2005, the number of patent applications has shown a certain growth trend. However, there are certain differences in the growth rate of solar energy technology during its rapid development. The application in Germany is relatively stable. The number of patent applications in Germany is less than 100 each year. South Korea had 354 patent applications in 2005 and reached the highest level of 589 in 2011. In the US, there were 351 patent applications in 2005, and 521 in 2010. The number of Japanese patent applications has increased from 192 in 2005 to 379 in 2012. The change in the number of patent applications indicates that South Korea, the United States, and Japan used to be prospective market in the solar energy field, but then it has a clear downward trend. For example, South Korea had only 128 patents in 2014, and the number of US patent applications in 2015 decreased to 143, Japan 2015 There are

already less than 100 items in the year. The overall decline in solar patent applications affected 4 major countries other than China. China's patent applications for solar energy have maintained a steady and rapid development trend. In 2005, there were 607 patent applications, which soared to 4116 in 2013. In 2015, it was as high as 4843, indicating that China, as an emerging market in the global solar energy market, is the most critical market now and attractive for applicators from all over the world.

### 3.3 Solar Energy Technology Global Competitors Analysis

This research got 69,479 patents in the field of solar energy technology and there are 70 technology application countries and 96 technology source countries. We found that top 4 patent application countries are China, the United States, Japan, and South Korea. These four countries are also four of the most important markets in the world. In consideration of France's competitive advantage in the field of solar energy technology, we choose the four major solar energy application countries mentioned above and France as the main competitors in the global market. As table 1 showed the global solar technology layout based on the distribution of their patent families.

Table 1. Local solar energy technology distribution of main patents application countries

Main patent application country	Local assignees' global patents application number	Number of patents distribution countries	Partition of local patents in all patent application (%)	Number of patents in areas	
				Aisia-pacific	33551
China	33925	19	98.62	Europe	56
				North America	109
				Else	209
				Aisia-pacific	1952
America	9291	37	48.49	Europe	1060
				North America	4837
				Else	1442
				Aisia-pacific	5459
Japan	6181	24	70.64	Europe	222
				North America	213
				Else	287
				Aisia-pacific	3825
Korea	4053	14	82.78	Europe	36
				North America	84
				Else	108
				Aisia-pacific	56
France	1066	16	85.18	Europe	968
				North America	26
				Else	16

### 3.4 Global core patents distribution

In order to identify the specific technology distribution of solar energy R&D and to further explore its development trend and concentration distribution more accurately, we count the number of these 670 patents by IPC class. We find 36 IPC class with more than 2 patents and table 5 shows 4 of them which has more than 10 patents for each class.

Table 2. Core solar patents technology distribution

IPC class	Tecnology	Patents number
F24J 2/00:	Solar thermal device	219
	Semiconductor devices sensitive to infra-red radiation, light, electromagnetic radiation of shorter wavelength, or corpuscular radiation and specially adapted either for the conversion of the energy of such radiation into electrical energy or for the control of electrical energy by such radiation	217
H01L 31/00:	Devices for producing mechanical power from solar energy	34
F03G 6/00:	Special arrangements or devices in connection with roof coverings	12
E04D 13/00:		

From Table 2, it can be seen that the global solar core technology are concentrated in the field of photothermic and photovoltaic, for 65% of the core patents are in class F24J 2/00 and H01L 31/00. And other class may be the future growth point of solar energy core technology.

We further analyzed these core patents application countries and found that the core patents gathered in 8 countries. They are the United States, China, Germany, Japan, the United Kingdom, WIPO and Canada. Table 6 shows countries with more than 10 core patented technologies:

Table 3. Core solar patents market distribution

Main application countries	Number of Core patents	Local core patents	Partition of local patents in application patents
America	506	396	78.26%
China	126	29	23.02%
Germany	12	11	91.67%

According to Table 3, the United States is the most important solar energy core technology application country. The majority of core patents are deployed in the United States and these core technologies are nearly applied by local companies, which indicating that the United States is both an important market and a powerful competitor. China is the second largest solar energy core technology application country. Statistics show that China is an important technology market who gain the attention of global core competitors. However, the proportion of domestic patents application of China is only 23.02%, indicating that local competitors do not have

technology advantages. This also confirms that China is an important country in the field of solar energy technology, not a powerful technology innovation country.

### 3.5 Solar technology distribution in China market

Of all the patents applied in China, 33,458 are from China, 3,757 from other countries in the world. Figure 7 is a view of patents distribution by IPC class in China:

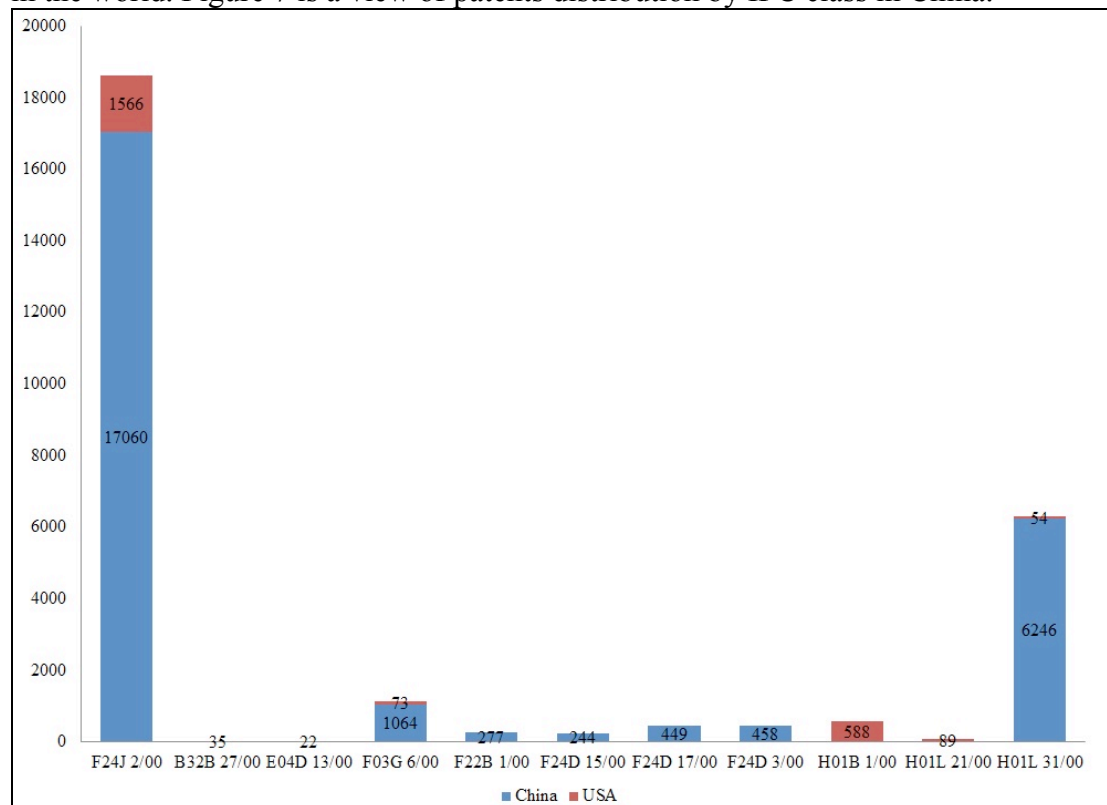

Figure 5. Solar energy technology distribution in China market

According to Figure 5, we found that applicants applied in China mainly focus on technologies belonged to F24J 2/00, H01L 31/00, and F03G 6/00 class, and the domestic applicants China also focus on these three technologies. The number of patent Chinese applications is large, even more than the total of other countries. Other countries also applied B32B 27/00, E04D 13/00, H01B 1/00, and H01L 21/00 patents in the China; in which H01L 21/00 and H01B 1/00 have relatively large volumes and are both related to semiconductor material technology. Semiconductor material technology is a technical shortcoming of Chinese local companies, and foreign companies have made up for the technical defects in Chinese market. Chinese local applicants have some patents distributed in F24D 3/00, F24D 17/00, F22B 1/00, F24D 15/00, which are related to residential hot water technology while others have no patents in this area.

## 4. Conclusion

This study analyzed the global solar technology competition situation and development trend, and the following is what we found:

From the perspective of patent application trends, global solar energy technology development state can be describe as three-phase before 2000 is introduction period,

from 2001 to 2006 is slow growth period and 2007 up till now is rapid development period. It can be predicted that in the next few years, solar energy is still in the rapid growth of technological life, and its development space and potential are huge.

From the perspective of patent application country, China, the United States, Japan, and South Korea are the main countries that apply for solar energy technology patents. The World Intellectual Property Organization, Germany, and the European Patent Office are also important applicants for solar energy technology. This is related to the global distribution of solar energy resources. Global climate change and renewable energy demand have a significant impact on the application of solar energy technology. The number of Chinese patent applications has been growing at a high rate and its global share has been rising. On the one hand, the solar energy industry has been supported by the national strategic emerging industries policy; on the other hand, China as a important market it has a strong attraction for applicants.

The patent text clustering results show that the global solar core patents are mainly concentrated in solar cells, solar energy, solar energy receivers, solar panels, and solar radiation fields. From the perspective of the IPC distribution of patent applications, we know that 65% of the core patents focus on F24J 2/00 and H01L 31/00 technology, and F03G 6/00 is also of great importance. In that case, it is obvious that technology about conversion of thermal energy and light radiation energy is critical in competition. global technology distribution in the China market also includes B32B 27/00, E04D 13/00, H01B 1/00, and H01L 21/00; among them H01L 21/00 and H01B 1/00 are relatively rich in patents and they are both related to semiconductor material technology. Some patents are distributed on F24D 3/00, F24D 17/00, F22B 1/00, F24D 15/00, which shows that China has obvious advantages in using solar energy for residential hot water technology. However, foreign companies have made up the technical deficiencies in Chinese market of semiconductor technology and materials in the process of solar energy utilization. For Chinese enterprises, it is conducive to evaluate the commercial potentiality of solar energy for residential hot water technology and invest semiconductor technology and materials in the process of solar energy utilization field. Furthermore, Chinese local applicants should continuously strengthen technological innovation, break through technical barriers, and grasp the right to speak in their own markets.

From the perspective of patent technology distribution, the Asia-Pacific region is the main battlefield for global solar technology deployment and the United States, Japan, South Korea, and France all have applied the largest number of patents in China except their domestic market. America and Japan have an obvious international patent layout with a partition of 50% and 30% patents in domestic market respectively, and both of them have mastered most of the core patents in the Chinese market. Although China is a major market, China's global patent distribution is weak comparing with other major solar energy application countries. China need an internationalization strategy urgently. Especially, China has fewer basic, original, high-value and core patents when compared with America and Japan. Faced with increasingly fierce global challenges and lack of international competitiveness, Chinese local R&D need to improve patents competitive advantage, grand core technological high ground, and expand international market.

## References

- Fan, X., Liu, W., & Zhu, G. (2017). Scientific linkage and technological innovation capabilities: international comparisons of patenting in the solar energy industry. *Scientometrics*, *111*(1), 117-138.
- Frietsch, R., & Schmoch, U. (2010). Transnational patents and international markets. *Scientometrics*, *82*(1), 185-200.
- Hoppmann, J., Peters, M., Schneider, M., & Hoffmann, V. H. (2013). The two faces of market support—How deployment policies affect technological exploration and exploitation in the solar photovoltaic industry. *Research Policy*, *42*(4), 989-1003.
- Johnstone, N., Haščič, I., & Popp, D. (2010). Renewable Energy Policies and Technological Innovation: Evidence Based on Patent Counts. *Environmental & Resource Economics*, *45*(1), 133-155.
- Pettersson, H., Nonumura, N., Kloo, L., & Hagfeldt, A. (2012). Trends in patent applications for dye-sensitized solar cells. *Energy & Environmental Science*, *5*(6), 7376-7380.
- Timilsina, G. R., Kurdgelashvili, L., & Narbel, P. A. (2012). Solar energy: Markets, economics and policies. *Renewable & Sustainable Energy Reviews*, *16*(1), 449-465.
- Tour, A. D. L., Glachant, M., & Ménière, Y. (2011). Innovation and international technology transfer: The case of the Chinese photovoltaic industry. *Energy Policy*, *39*(2), 761-770.
- Zhang, X. (2014). Interactive patent classification based on multi-classifier fusion and active learning. *Neurocomputing*, *127*(3), 200-205.
- Zhao, R., Zhao, L., Deng, S., & Zheng, N. (2015). Trends in patents for solar thermal utilization in China. *Renewable & Sustainable Energy Reviews*, *52*, 852-862.
- Luan, C. J., Liu Z. Y., & Wang, X., W. (2013). Divergence and Convergence: analysis on evolving trend of technology relatness – case sutdy on patentometrics of worldwild solar energy technology. *Research and Management Development*, *25*(4), 87-95.
- ZHANG, G. P., & Chen, X. D. (2013). Analysis on patant qulity in new energy techonology field: a case study on wind energy and solar energytechnologies. *Research and Management Development*, *25*(1), 73-81.

**Contact email:** liuchangxin@casipm.ac.cn



***Evaluation of Social Sustainability in Building Projects: Theoretical Framework and Impact Assessment Approach***

Siyu Liu, Nanyang Technological University, Singapore  
Shunzhi Qian, Nanyang Technological University, Singapore

The Asian Conference on Sustainability, Energy & the Environment 2018  
Official Conference Proceedings

**Abstract**

Recognizing the importance of building-specific social impact assessment tools to the achievement of social sustainability of building projects, this study developed a methodological framework for life-cycle social sustainability assessment of building projects through stakeholder-based approach. The assessment framework was firstly proposed considering four stakeholders, including worker, occupant, local community and society, and impact subcategories associated with different social concerns. Indicators were then selected for each subcategory based on the assessment objective and data availability. They were categorized into three groups, including quantitative indicators in generic analysis, as well as quantitative and semi-quantitative indicators in site-specific analysis, and corresponding scoring method were provided. Finally, weights among impact subcategories were generated through questionnaire survey based on AHP method using consistent fuzzy preference relations (CFPR), and weights among life-cycle phases were determined considering the possibility to place control as well as level of concern of construction practitioners. In summary, the proposed method applies multi-stakeholder approach and includes several life-cycle phases which enables the investigation on potential transfer of impacts between life-cycle phases.

Keywords: social sustainability, social life cycle assessment (S-LCA), life cycle perspective; multi-stakeholder approach, AHP

**iafor**

The International Academic Forum  
[www.iafor.org](http://www.iafor.org)

## Introduction

Buildings and their relevant processes have significant influence on three key dimensions of sustainability, i.e., environmental, economic and social dimensions, in both positive and negative manners (Kamali & Hewage, 2017). On one hand, building projects satisfy human being's basic needs and improve life quality, create employment opportunities, and further contribute to national economy (Love & Irani, 2004; Zuo & Zhao, 2014). On the other hand, building projects consume raw materials and energy to construct and operate, release greenhouse gases (GHG), generate solid waste, cause pollution and occupy land (Ding, 2008; Wong & Fan, 2013). In addition, building projects are responsible for some safety and health issues during construction process (Shen, Tam, Tam, & Ji, 2010; Zhang, Wu, & Shen, 2015). The quality of building products and indoor environment also have great effect on occupational health (Zuo et al., 2017).

With increasing awareness of above-mentioned issues, efforts have been made in construction industry, shifting from traditional focuses of time and cost only, towards much broader ones. However, these efforts are mainly directed at reducing negative environmental impacts while social sustainability has not been properly addressed (Gould, Missimer, & Mesquita, 2017; Hutchins & Sutherland, 2008). Social sustainability involves multi-faceted social values, which are sequentially influenced by plentiful stakeholders (Almahmoud & Doloi, 2015). A socially sustainable building project is supposed to respond to the different requirements of multiple stakeholders involved in the whole process of the building project development, including not only the final users but also construction personnel, suppliers and local communities (Hussin, Rahman, & Memon, 2013; Valdes-Vasquez & Klotz, 2012; Wong & Fan, 2013).

However, social impact assessments with a proper coverage of relevant stakeholders for building project evaluation is still lacking (Valdes-Vasquez & Klotz, 2012; Zhao, Zhao, Davidson, & Zuo, 2012). This study thus aims to develop a methodological framework for social sustainability assessment of building projects through stakeholder interest-based approach. In this work, social life cycle assessment (S-LCA) method was adopted as the basis to assess the potential positive and negative social impact of products, processes, services or systems throughout their life cycle. Such life-cycle perspective enables the consideration of potential transfer of impacts between different life cycle phases, impact categories and regions.

S-LCA is regarded as a parallel to the environmental life cycle assessment (E-LCA) (Ekener, Hansson, & Gustavsson, 2018). However, unlike E-LCA that is standardized by ISO 14040 and 14044, there is no consensus on the specific or consistent S-LCA method. One significant step towards its standardization is the publication of Guidelines for Social Life Cycle Assessment of Products (Benoît et al., 2009) (hereafter referred to as the Guideline), which provides a general framework with methodological sheets for 31 social impact subcategories regarding different aspects of social concerns. In the Guideline, social impacts are observed in five stakeholder categories, including workers, local community, consumer, society and value chain actors. Such stakeholder-based approach is consistent with our initial consideration for framework development.

The Guideline has been applied and tested in many case studies in various industrial contexts with different objectives, including some building-specific analyses, such as (Dong & Ng, 2015; Hosseini, Mansour, & Shirazi, 2014). While using the Guideline as the basis for their analysis, previous cases studies vary greatly regarding the detailed methodological choices to conduct S-LCA studies depending upon difference purposes and application scenarios (Macombe, Feschet, Garrabé, & Loeillet, 2011; Reiting, Dumke, Barosevic, & Hillerbrand, 2011). Several key issues regarding methodological choices are identified from previous studies. The fundamental one is the identification of relevant stakeholders and social issues. Although the Guideline identifies hundreds of social issues, not all of them are directly relevant to the analysis. Social issues can be identified differently under different regional and industrial scenario. Therefore, a set of social issues associated with various stakeholders related to different life cycle phases of building projects needs to be understood before conducting S-LCA. Sequentially, weights among the selected impact categories need to be determined properly.

Another issue is associated with the social indicators to characterize the social issues identified. In S-LCA studies, data can be collected from either generic or site-specific sources; impacts can be captured through quantitative, semi-quantitative or qualitative indicators. Both data source and indicator type, and even different policy or industrial requirement, may lead to different choices of indicator for a certain impact category. Hence, a specific set of indicators needs to be developed depending on the goal and scope definition as well as data accessibility. Besides, the choice of the reference performance for each indicator needs to be justified for quantitatively illustrating social performance. The reference performance could be determined based on the minimal legal requirements, sectorial standards and average performance, as well as the best expected practices within the industry (Revéret, Couture, & Parent, 2015).

This study contributes to the development of social sustainability assessment of building projects through addressing the above-mentioned issues regarding S-LCA and proposing a method to calculate social impact scores. The proposed theoretical framework for social sustainability assessment is presented in next section, with the definition of stakeholder and relevant impact subcategories. The methodology for social impact assessment is then elaborated, including indicators selection, weights determination, and calculation of social impact scores. This is followed by a case study comparing two building structures with different construction methods. Conclusion and future work are discussed in the last section.

### **Theoretical framework for social sustainability assessment**

This section presents the selection and definition of social impact categories, which form the theoretical framework for social sustainability assessment of building projects. Consistent with the stakeholder-based approach in the Guideline, stakeholder categories were firstly identified to cover groups of people that are potentially affected by life-cycle activities, followed by the selection of social subcategories under each stakeholder category to illustrate different aspects of social concerns.

In this study, four main life cycle phases of building projects were considered, including raw material extraction, building material or products manufacturing, on-site construction, and operation and maintenance (O&M). Accordingly, four

stakeholder categories were identified, including: a) workers, which refer to people working in manufacturing plant or on mining/construction site; b) occupants of the building; c) local communities, which refer to those who live in the close proximity to a production site or construction site, and thus directly affected by the production or construction activities; and d) society, which refers to the general public in the region where the building project is located and is indirectly affected regarding acknowledged social values (Manik et al., 2013; Siebert, Bezama, O’Keeffe, & Thrän, 2016).

Figure 1 illustrates how activities within different life cycle phases are linked to the stakeholder categories. For raw material extraction and manufacturing phase, many materials or products are required, and thus various organizations are involved and cause different impacts. Consequently, assessment should be performed separately by organizations. As for the construction and O&M phase, although several companies representing owners, contractors, designers, etc. are involved, only one integrated organization, i.e., project team, will be assessed. That is because building projects are delivered through a temporary and dynamic team. Stakeholder category “society” is not directly linked to any life cycle phase; it is how the development of a certain building project causes the change of industrial environment or society (specifically Singapore in this study) that will be examined.

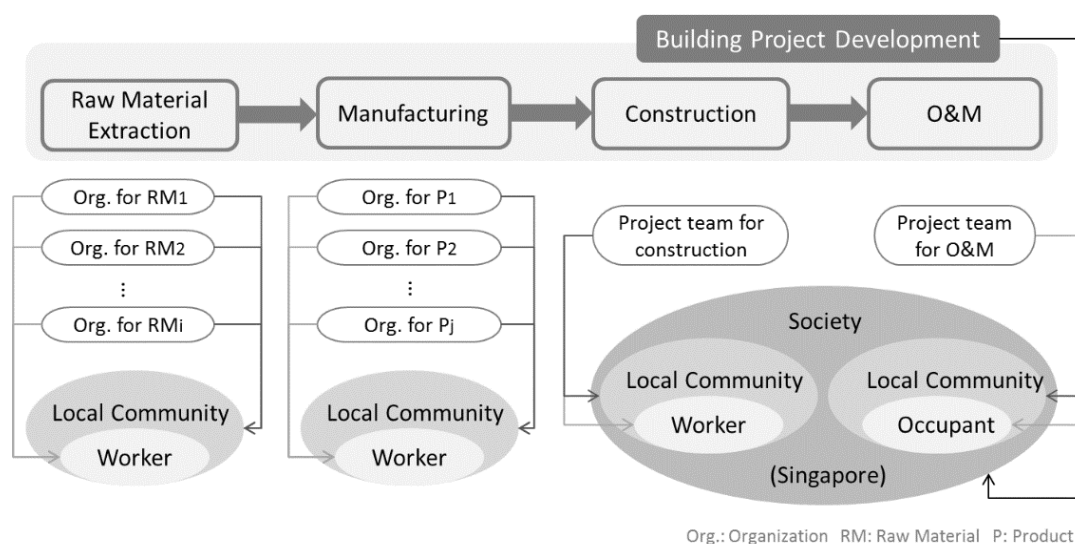

Figure 1: Relationship between life cycle phases and stakeholder categories

The selection of social impact subcategories was based on the Guideline and 15 previous studies that developed building-specific criteria for social impact assessment (Ali & Al Nsairat, 2009; Almahmoud & Doloi, 2015; Alwaer & Clements-Croome, 2010; Andrade & Bragança, 2011; Bragança, Mateus, & Koukkari, 2010; Chan & Lee, 2008; Y. Chen, Okudan, & Riley, 2010; Dave, 2011; Kamali & Hewage, 2015; Nguyen & Altan, 2011; Pan, Dainty, & Gibb, 2012; L.-y. Shen et al., 2010; L. Y. Shen, Li Hao, Tam, & Yao, 2007; Valdes-Vasquez & Klotz, 2012; Yunus & Yang, 2011). It is worth mentioning that previous building-specific studies usually only focus on construction and O&M phases, while enlarged boundary in this study, i.e., including four main life-cycle phases, leads to a broader set of impact categories. Social impact categories included in this study are summarized in Table 1.

Table 1: Selection of stakeholder categories and subcategories

Social Impact Category		Source	
Stakeholder Category	Subcategory	the Guideline (original expression if any change)	Papers (count of papers mentioning a certain subcategory)
Worker	Health and safety of workers	√	√ (8)
	Fair Salary	√	×
	Working Hours	√	×
	Discrimination	√	×
	Forced Labour	√	×
	Child Labour	√	×
Occupant	Functionality and Usability	√ (safety & health)	√ (8)
	Health and Comfort	√ (safety & health)	√ (14)
	Accessibility	×	√ (6)
	Feedback Mechanism	√	×
Local Community	Safety and Health	√ (safe, healthy and secure living conditions)	√ (9)
	Accessibility	√ (access to material resources)	√ (6)
	Integration and Interaction	√ (local engagement; cultural heritage)	√ (7)
	Local Employment	√	√ (6)
Society	Technology development	√	√ (3)
	Public commitments to sustainability issues	√	×

For category “workers”, *safety and health* is the only aspect discussed in previous papers. It evaluates the quality and efficiency of safety management within an organization, mainly including the provision of necessary and enough safety measures, equipment, facilities, information and trainings to the workers. Apart from safety and health protection, the Guideline also highlights the importance of protecting human rights, particularly workers’ rights here, which is seldom included in previous building-specific criteria. Therefore, five subcategories, including *fair salary*, *working hours*, *discrimination*, *forced labour*, *child labour*, are added to consider human rights including right to free choice of employment, right to equal pay for equal work without any discrimination, right to just remuneration and right to rest brought by reasonable working hours and periodic holidays with pay.

Category “occupants”, named “consumer” in the Guideline, is mostly discussed in building-specific studies as it is about the core function of buildings. *Safety and health* in the Guidelines is divided into two subcategories, *functionality and usability*, and *health and comfort*. *Functionality and usability* assesses how well the project meets its functional needs and provides building facilities and features depending on different usage purposes. Particularly, it focuses on the provision of essential

amenities such as drinking water, toilet, first aid, etc., as well as safety and security issues, including building's ability to protect the residents from external harm events, provide safe internal installations and security measures to avoid risk of harm due to intentional criminal acts such as assault, burglary or vandalism. *Health and comfort* basically assesses indoor environmental quality (IEQ). IEQ is regarded to directly influence the health, comfort and well-being of occupants (De Giuli et al., 2012), which is illustrated by several aspects such as indoor air quality, hydrothermal comfort, acoustic comfort and visual comfort.

*Accessibility* is another essential factor in improving social sustainability through increasing occupants' satisfaction. People are always willing to have proper and convenient access to certain places in their daily lives (Chan and Lee, 2008); thus they care about how building is linked to places such as public transport nodes, daily use shops, health facilities, etc. The last subcategory is *feedback mechanism*, which is tightly related to the occupants' satisfaction related to building services. Efficient feedback mechanism should at least make sure any complaints concerning the building normal operation can be solved within a reasonable time.

As for category "local community", *safety and health* assesses whether production activities in factories or on-site construction work have a good control of noise generation, pollution and dust emission as well as a good waste management to avoid harming neighbors' health and comfort. It also evaluates whether there is any safety risk around construction site, such as falling objects, uncovered holes in the road or pavement, poor lighting and uneven surfaces, etc. *Accessibility* for the surroundings means differently for different phases. During construction phase, accessibility assesses how construction works affect people's daily travel time and distance and decrease the mobility of daily life (Andersson and Johansson, 2012); while during O&M phase, surrounding residents see accessibility as whether the project respects, protects, provides or improves community access to infrastructures, such as roads, facilities, drainage, and even open spaces, parking areas, green areas, etc.

*Integration and Interaction* is to assess how a project is integrated into the local community, and how it interacts with community stakeholders. This subcategory requires a project to respect the social value of a community, to preserve the local characteristics, to engage community stakeholders in relevant decision-making processes and listen to their voices, to respond to communities' concerns and perceptions effectively, as well as to establish a communication path to encourage such interaction and integration. The last subcategory, *local employment*, investigates both direct and indirect influence of a project on local employment. Local hiring preferences provide important income and training opportunities to community members. Furthermore, developing relationships with locally-based suppliers will further encourage local employment and development.

For category "society", *technology development* examines technology development strategies of an organization. It may include involvement in technology transfer program, partnerships in research and development, or investments in technology development/technology transfer regarding building products, systems, construction methods, services, techniques, or management models. Another category, *public commitments to sustainability issues*, is related to the broader meaning of organizational social responsibility. It assesses whether an organization prepare

publicly available documents as promises or agreements on sustainability issues to its customers, shareholders, local community or the public.

### Methodology for social impact assessment

This section addresses the issues related to social impact assessment, which are illustrated by Figure 2. One or more social indicators were selected to characterize each impact subcategory (as listed in Table 1). Three groups of indicators were used in this methodology and they applied different scoring methods, which are explained separately in the subsections. To integrate these social performance scores (SPS), weights among life-cycle phases and impact categories were generated.

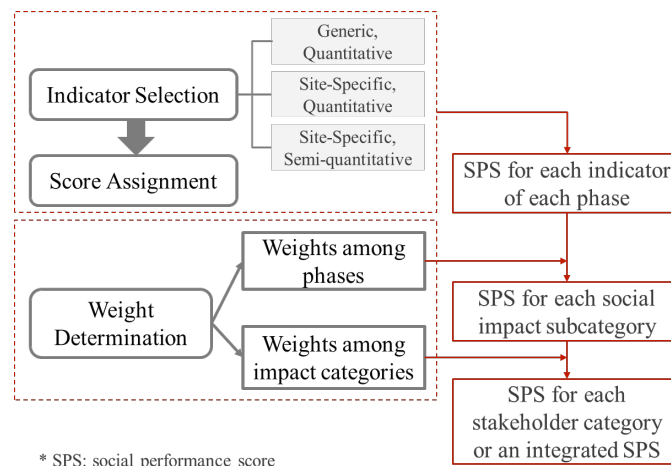

Figure 2: methodological framework for social impact assessment

### Indicators Selection

Indicator selection is influenced by the nature of the assessment objective and data availability. Site-specific data obtained by investigating organizational operation are generally more favorable to evaluate social impact compared with generic statistical data (L. Dreyer, Hauschild, & Schierbeck, 2006; Jørgensen, Le Bocq, Nazarkina, & Hauschild, 2008; Kruse, Flysjö, Kasperczyk, & Scholz, 2009). However, such information is not always available. From life cycle perspective, main activities of a project team lie in construction and O&M phases, and the building evaluation is always conducted during the design phase, or before buildings being put into operation. The availability of detailed information will be lower if the activities are located farther from the center, as indicated in Figure 3. Therefore, this study uses both generic and site-specific data, as shown in Figure 3.

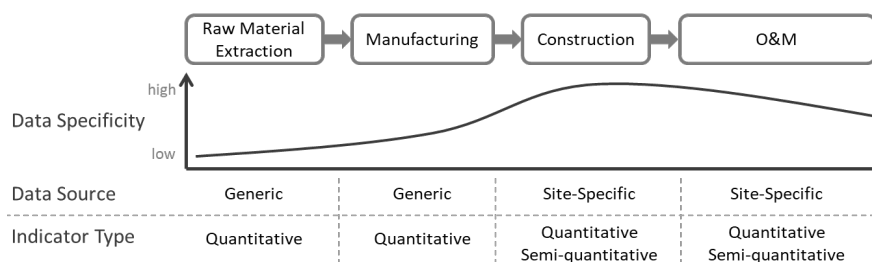

Figure 3: Data specificity change along life cycle phases and their corresponding data sources and indicator types

To obtain quantitative results, indicators can be quantitative or semi-quantitative. Quantitative indicators describe assessed issues using specific values, for instance, number of work accidents. Semi-quantitative indicators are quantification of qualitative indicators which usually use a scoring system or a yes/no form, for example, giving score for company performance regarding human rights protection using a scale of 1 to 5. As shown in Figure 3, for the analyses based on the generic data, indicators are all quantitative since statistical data at the country and industry level are used. As for site-specific analyses, both quantitative and semi-quantitative indicators are involved, since quantitative indicators sometimes cannot properly describe the real case situation (L. C. Dreyer, Hauschild, & Schierbeck, 2010).

Based on the previous discussion, indicators were selected separately for generic analysis and site-specific analysis involving both quantitative and semi-quantitative indicators. The selection of indicators and their corresponding data sources, as summarized in Table 2 (for generic analysis) and Table 3 (for site-specific analysis), were on the basis of methodological sheets of *the Guideline* (Benoît et al., 2009); further selection was based on the relevancy to construction sector context or Singapore context and data availability.

Table 2: Selection of indicators for generic analysis

Subcategory	Indicators for generic analysis	Sources
Health and safety (worker)	Non-fatal and fatal occupational injuries per 100,000 workers	(Hämäläinen, Takala, & Saarela, 2006)
Fair Salary	Ratio between average sector wage and living wage	(Communities, 2009; ILO, 2017)
Working Hours	Excessive weekly working hours per employed person compared with 48 hours	(ILO, 2017)
Discrimination	Gender inequality index	(Selim Jahan, Eva Jespersen, & Mukherjee, 2016)
Forced Labor	Proportion of population in modern slavery	(WalkFree, 2016)
Child Labor	Percentage of children 5-14 years old involved in child labor	(UNICEF, 2017)
Safety and Health (Local community)	Reliability of police services	(Klaus Schwab, Xavier Sala-i-Martin, & Samans, 2018)
	Burden of disease	(WHO, 2015)
	Dealing with construction permits	(WorldBank, 2017)
Accessibility (Local community)	Percentage of population with access to improved water source and improved sanitation facilities	(WorldBank, 2016)
	Quality of road	(Klaus Schwab et al., 2018)
Integration and Interaction	Transparency of government Policymaking Public trust in politicians	(Klaus Schwab et al., 2018)
Local Employment	Unemployment rate	(WorldBank, 2016)
	Local supplier quantity	(Klaus Schwab et al., 2018)



Table 3: Selection of indicators for site-specific analysis

Subcategory	Indicators
Health and safety (worker)	Status of managerial practices; Accident frequency rate
Fair Salary	Status of managerial practices; Percentage of workers whose wages meet at least legal minimum wage or sectorial standard; Percentage of workers who are paid a living wage.
Working Hours	Status of managerial practices; Contractual working hours; Management of overtime
Discrimination	Status of managerial practices; Numbers of incidents of discrimination
Forced Labor	Status of managerial practices; Numbers of forced labor
Child Labor	Status of managerial practices; Numbers of child labor
Functionality and Usability	Status of design consideration; Performance regarding meeting functionality needs and provision of essential amenities and building equipment
Health and Comfort	Status of design consideration; Performance regarding indoor air quality, acoustic comfort, hydrothermal comfort and visual comfort
Accessibility (occupants)	Status of design consideration; Performance regarding proximity to public transportations and amenities
Feedback Mechanism	Status of managerial practices; Performance regarding efficiency of dealing with fault reporting and general enquiries
Safety and Health (Local community)	Status of managerial practices; Performance regarding controlling disturbance to surroundings regarding dust emission, noise emission, and preventing safety issues
Accessibility (Local community)	Status of managerial practices; Performance regarding preventing mobility disturbance (construction phase); Status of design consideration; Performance regarding proving open places, paths and facility for public (O&M phase)
Integration and Interaction	Status of managerial practices; Performance regarding the preservation of local characteristics, and involvement of neighbourhoods into project-related activities, such as design and construction process planning, knowledge sharing and skill transfer
Local Employment	Status of managerial practices; Percentage of workforce hired locally; Percentage of spending on locally-based suppliers.
Technology development	Status of managerial practices; Performance regarding technology development strategies
Public Commitment to Sustainability Issues	Status of managerial practices; Performance regarding public sustainability reporting

### ***Scoring of indicators***

As listed in Table 2, three groups of indicators are involved, including quantitative indicators in generic analysis, as well as quantitative and semi-quantitative indicators

in site-specific analysis. Indicators need to be scored and normalized to a range of -2 to +2 in order to be further integrated to single social performance scores.

### ***(a) Quantitative Indicators in Generic Analysis***

Before conducting generic analysis, country-level performance scores regarding each impact indicator need to be prepared using national statistical data. Statistical data were collected from several online databases or international reports, as indicated in Table 2, and were normalized to a range of -2 to +2. Positive values represent above-average or favorable social performance, while negative ones show poor social performance or negative impact. For example, country-level statistics regarding non-fatal occupational injuries rate (Hämäläinen et al., 2006) were normalized between -2 to +2 where country with lowest injuries rate was assigned a score of 2, and country with the highest injuries rate was assigned a score of -2. As mentioned, the normalization rule is based on the actual social meaning of the indicator, rather than all being normalized according to maximum and minimum values. For example, most of the countries do not have issues of child labor according to statistics (UNICEF, 2017); thus countries with 0% were scored as 2, while others are normalized to -2~0.

With country-level performance scores, data collection for generic analysis focuses on the identification of main countries involved in certain phases (particularly raw material extraction and production phase), and the activity contribution of these countries. In this study, weight proportions of building materials serve as the basis for calculation, as adopted in previous studies (Ekener-Petersen & Finnveden, 2013; Gould et al., 2017); while activity contributions of countries are connected to these materials through worldwide extraction statistics and export or import data.

For raw material extraction phase, weights of raw materials are estimated based on the quantity of building materials that can be identified using Bill of Quantity or other project records. These materials can be split into raw materials based on general production information of a certain material. For example, integrated steelmaking route requires 1.4 kg of iron ore, 0.8 kg of coal, 0.3 kg of limestone and 0.12 kg of recycled steel to produce 1 kg of crude steel (Worldsteel, 2018). Such information indicates the extraction forms of raw materials and allows the conversion to percentage composition of all the raw materials involved. For each raw material, main extraction locations and percentage of extraction from each country can be obtained from the statistics. In this study, Mineral Commodity Statistics (USGS, 2017) and World Mineral Production (Brown et al., 2014) were used to identify dominant countries that contribute around 90% of total world extraction, which are then used to represent all contributing countries for simplification.

For manufacturing phase, indicators are scored following the similar process. Differently, the activity contribution of each country could be calculated based on more specific and accurate information, such as project purchasing or supplier records, showing actual origins of a certain building material or product. Alternatively, for building materials or products that are directly related to assembly or construction activities in Singapore, country activity distribution can be determined using Singapore-specific statistical data, such as import statistics (COMTRADE, 2017; Simoes, 2017), instead of using worldwide statistical data. For example, considering sand usage in Singapore relies greatly on import, country activity

contribution for sand was estimated using import data, according to which Malaysia (65.3%), Vietnam (20.4%) and Cambodia (14.3%) are the top three contributors for sand mining.

Accordingly, the contribution of activities in  $j$ th country (activity contribution,  $AC_j$ ) involved in a certain life cycle stage can be obtained through integrating quantity proportion of  $k$ th material (quantity proportion,  $QP_k$ ) and country activity contributions regarding individual materials ( $AC_{jk}$ ), as indicated by Equation (1).

$$AC_j = \sum QP_k \times AC_{jk} \quad (1)$$

With the normalized social performance score of  $j$ th country for  $i$ th indicator (country-level performance score,  $CPS_{ij}$ ), and the activities contribution occurred in each country ( $AC_j$ ), the integrated normalized social performance score of  $i$ th indicator (social performance score,  $SPS_i$ ) can be obtained by,

$$SPS_i = \sum CPS_{ij} \times AC_j \quad (2)$$

### **(b) Quantitative Indicators in Site-specific Analysis**

Scores for quantitative indicators are obtained using performance reference values (PRVs), which can be country and/or sector average performance values. Specific calculation depends highly on the actual meaning of the indicators. For instance, to score performance regarding local employment, percentage of local workforce in a project is selected as indicator, and both sector and country statistical data were used as PRVs, being 14% and 63% respectively. 63%, rather than 100%, is given the score of +2, considering 63% is seen as the optimistic (best) performance in the context of Singapore; 14% is given the score of 0, indicating the standard and average performance level. Accordingly, performance score is obtained through normalizing project-specific percentage of local workforce, e.g. project with 20% being local workforce obtains the score of 0.24 ( $= (20\% - 14\%) / (63\% - 14\%)$ ).

### **(c) Semi-quantitative Indicators in Site-specific Analysis**

Scores for semi-quantitative indicators are obtained based on experts' verbal and qualitative assessments and their further conversion to numbers. The assessment is based on the performance reference scales (PRS), including five performance levels, namely, very poor (VP), poor (P), fair (F), good (G), very good (VG), and corresponding performance descriptions of each level. Project team members (such as engineers and project managers) or multi-stakeholder (which may include occupants, local community, workers) are required to carefully check the descriptions provided and select the suitable performance level based on their opinion.

Assessment results are then converted into triangular fuzzy numbers  $\tilde{x}_i^m = (a, b, c)$  using Figure 4 to represent  $m$ th evaluator's assessment regarding  $i$ th indicator, where  $a$ ,  $b$ , and  $c$  are the membership function parameters. Adoption of fuzzy numbers can address the imprecision and uncertainty that is inherent to the human judgments in the decision-making process (Ren, Manzardo, Mazzi, Zuliani, & Scipioni, 2015). Later,

all the assessment results are aggregated into group evaluation results by applying the fuzzy averaging operator, which is defined by:

$$\tilde{x}_{ik} = \frac{1}{M} [\tilde{x}_i^1(+) \tilde{x}_i^2(+) \dots (+) \tilde{x}_i^M], \quad (3)$$

where M is the number of experts.

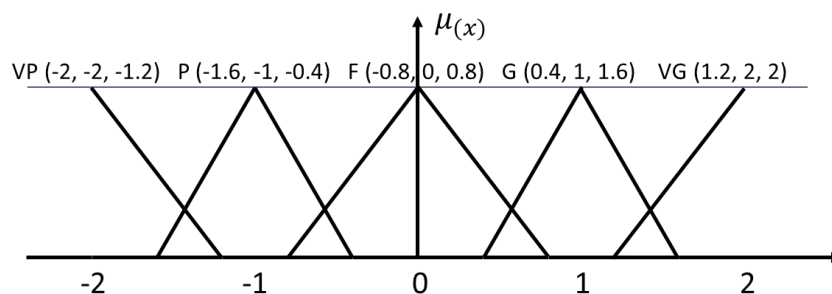

Figure 4: Membership function of linguistic terms

Note: Linguistic scales and their corresponding fuzzy numbers adopt the definition of (Hsieh, Lu, & Tzeng, 2004) which is proportionally transformed between -2 and 2.

Finally, fuzzy evaluation results are then defuzzified based on centroid of area (COA) method, as indicated by Eq. (4), which are the scores for semi-quantitative indicators.

$$x'_i = \frac{a+b+c}{3} \quad (4)$$

### Weight Generation

Weights among social impact subcategories were obtained through questionnaire survey. The main part of the questionnaire was designed in a pairwise comparison manner, which was based on AHP method using consistent fuzzy preference relations (CFPR). Linguistic terms are used to describe the relevant importance and are converted into corresponding numbers for further calculation. CFPR-based AHP can be seen as the deviation of the traditional AHP process. Traditional AHP process involves  $n(n-1)/2$  pairs of comparison in a group of  $n$  criteria, which brings some issues when there are too many criteria involved. Faced with a quite long questionnaire, experts usually do not have enough time or patience to complete it. Furthermore, too many pairs of comparison may cause experts' mental confusion, resulting in inconsistent responses, in which case, the questionnaire needs to be checked and re-answered, leading to inefficiency (Y.-H. Chen & Chao, 2012). However, in CFPR-based AHP,  $i$ th criterion is only compared with  $(i+1)$ th criterion, which means only  $(n-1)$  judgments are involved, and consistency can also be guaranteed. For detailed methodology of CFPR-based AHP, please refer to previous studies, such as (Herrera-Viedma, Herrera, Chiclana, & Luque, 2004) and (Wang et al., 2016).

Questionnaires, including respondents' basic information, main pairwise comparison part and corresponding explanations, were delivered via face-to-face distribution or e-mail to local construction experts. In total 67 feedbacks were received with a response rate of 72.3%. The respondents covered various stakeholders as shown in Figure 5. Based on the questionnaire survey results, weights were derived as showed in Table 4.

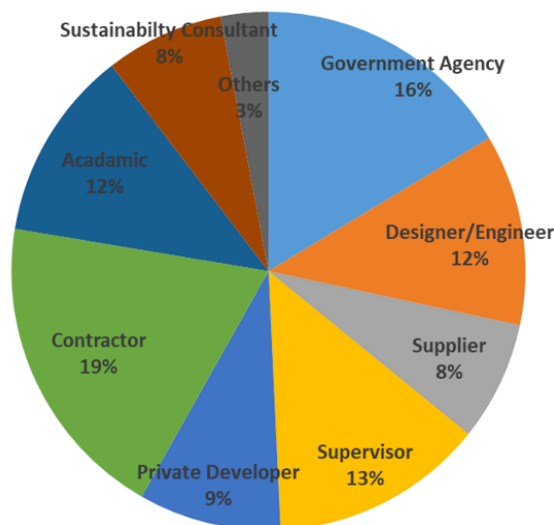

Figure 5: Distribution of responses of questionnaire survey

Table 4: Weights of Social Impact Categories

Stakeholder Category	Subcategory	Local weights	Global weights
<b>Worker</b>		<b>0.273</b>	
	Health and Safety	0.254	0.069
	Fair Salary	0.233	0.064
	Working Hours	0.186	0.051
	Discrimination	0.175	0.048
	Forced Labour	0.085	0.023
	Child Labour	0.067	0.018
<b>Occupant</b>		<b>0.283</b>	
	Functionality and Usability	0.312	0.088
	Health and Comfort	0.307	0.087
	Accessibility	0.209	0.059
	Feedback Mechanism	0.172	0.049
<b>Local Community</b>		<b>0.243</b>	
	Safety and Health	0.343	0.083
	Accessibility	0.191	0.046
	Integration and Interaction	0.170	0.041
	Local Employment	0.296	0.072
<b>Society</b>		<b>0.201</b>	
	Technology development	0.621	0.125
	Public Commitment to Sustainability Issues	0.379	0.076

Another set of weights are weights among life cycle phases. Previous studies usually use activity variables to “reflect the share of a given activity associated with each unit process” and to describe the relevance of impacts caused by a process in a life cycle. Currently, the most common activity variable is worker hours, i.e. the time workers spend to produce certain amount of products in the given process or sector. However, strictly speaking, worker hours are only related to the stakeholder workers (Ciroth & Eisfeldt, 2016), which is very relevant in previous studies that only discuss topics

regarding labor conditions. In this study, worker hours, however, may not be a suitable activity variable as it includes multiple stakeholders.

This study indicatively estimated the relative importance of each phase based on two considerations, as shown in Table 5. One is the degree of possibility to place control. As indicated in Figure 3, data specificity is lower if the activities are located farther from the center phases; so is the control possibility. Therefore, the possibility to control is ranked from high to low as follows: construction phase, use phase, production phase, and raw material extraction phase. Use phase is weaker than construction phase due to its longer time span (around 50 years). Another aspect is level of concern of construction practitioners, whose focus is on construction and use phase; raw material extraction was given a relatively higher score, since mining industry is believed to have much severer negative social impact compared with manufacturing industry. A total score of 100 was allocated to four phases for each aspect of consideration, and for each phase mean of two scores was calculated and converted to weight.

Table 5: Weights of life cycle phases

	Raw Material Extraction	Production	Construction	Use
Control	5	15	50	30
Concern	25	5	30	40
Weight	0.15	0.10	0.40	0.35

## Conclusion

This study proposed a methodological framework for social sustainability assessment of building projects. It applies multi-stakeholder approach and includes several life-cycle phases in the analysis which enables the investigation on potential transfer of impacts between life-cycle phases.

A theoretical framework for social sustainability assessment was firstly constructed through the identification of relevant stakeholders (in this study, worker, occupant, local community and society) and impact subcategories associated with each stakeholder category. Weights among these impact subcategories were then generated through questionnaire survey based on CFPR-based AHP method. As for weights among life-cycle phases, they were determined considering the degree of possibility to place control as well as level of concern of construction practitioners. Indicators were selected for each impact subcategory based on the assessment objective and data availability, which were categorized into three groups by data source and indicator type, including quantitative indicators in generic analysis, as well as quantitative and semi-quantitative indicators in site-specific analysis. For generic analysis, SPS were obtained by integrating country activity contribution and normalized country-level performance scores, which were calculated from different sources of statistics. For site-specific analysis, scores for semi-quantitative indicators were obtained based on PRS, while score for quantitative indicators were calculated using actual performance data and PRVs, which can be country and/or sector average performance values.

This study proposed an extensive methodology for social sustainability assessment of building projects. However, there are still methodological issues that require further

attention. Indicators selected to characterize impact categories need continuous improvement through investigation of cause-effect relationships. Furthermore, data availability for social assessment also restricts the selection of indicators, which highlights the need to establish relevant database. Accordingly, the analysis scope could be broadened to include maintenance and end-of-life phases, which were excluded in this study due to data unavailability.

## References

- Almahmoud, E., & Doloï, H. K. (2015). Assessment of social sustainability in construction projects using social network analysis. *Facilities*, 33(3/4), 152-176.
- Benoît, C., Norris, G. A., Valdivia, S., Ciroth, A., Moberg, A., Bos, U., . . . Beck, T. (2009). The guidelines for social life cycle assessment of products: just in time! *The International Journal of Life Cycle Assessment*, 15(2), 156-163.
- Ciroth, A., & Franze, J. (2011). LCA of an ecolabeled notebook: consideration of social and environmental impacts along the entire life cycle: Lulu. com.
- Ding, G. K. (2008). Sustainable construction—The role of environmental assessment tools. *Journal of environmental management*, 86(3), 451-464.
- Dong, Y. H., & Ng, S. T. (2015). A social life cycle assessment model for building construction in Hong Kong. *The International Journal of Life Cycle Assessment*, 20(8), 1166-1180.
- Ekenær-Petersen, E., & Finnveden, G. (2013). Potential hotspots identified by social LCA—part 1: a case study of a laptop computer. *The International Journal of Life Cycle Assessment*, 18(1), 127-143.
- Ekenær, E., Hansson, J., & Gustavsson, M. (2018). Addressing positive impacts in social LCA—discussing current and new approaches exemplified by the case of vehicle fuels. *The International Journal of Life Cycle Assessment*, 23(3), 556-568.
- Foolmaun, R. K., & Ramjeeawon, T. (2013). Comparative life cycle assessment and social life cycle assessment of used polyethylene terephthalate (PET) bottles in Mauritius. *The International Journal of Life Cycle Assessment*, 18(1), 155-171.
- Franze, J., & Ciroth, A. (2011). A comparison of cut roses from Ecuador and the Netherlands. *The International Journal of Life Cycle Assessment*, 16(4), 366-379.
- Gould, R., Missimer, M., & Mesquita, P. L. (2017). Using social sustainability principles to analyse activities of the extraction lifecycle phase: learnings from designing support for concept selection. *Journal of Cleaner Production*, 140, 267-276.
- Hosseinijou, S. A., Mansour, S., & Shirazi, M. A. (2014). Social life cycle assessment for material selection: a case study of building materials. *The International Journal of Life Cycle Assessment*, 19(3), 620-645.
- Hussin, J. M., Rahman, I. A., & Memon, A. H. (2013). The way forward in sustainable construction: issues and challenges. *International Journal of Advances in Applied Sciences*, 2(1), 15-24.
- Hutchins, M. J., & Sutherland, J. W. (2008). An exploration of measures of social sustainability and their application to supply chain decisions. *Journal of Cleaner Production*, 16(15), 1688-1698.



- Kamali, M., & Hewage, K. (2017). Development of performance criteria for sustainability evaluation of modular versus conventional construction methods. *Journal of Cleaner Production*, 142, 3592-3606.
- Love, P. E., & Irani, Z. (2004). An exploratory study of information technology evaluation and benefits management practices of SMEs in the construction industry. *Information & Management*, 42(1), 227-242.
- Macombe, C., Feschet, P., Garrabé, M., & Loeillet, D. (2011). 2nd International Seminar in Social Life Cycle Assessment—recent developments in assessing the social impacts of product life cycles. *The International Journal of Life Cycle Assessment*, 16(9), 940.
- Manik, Y., Leahy, J., & Halog, A. (2013). Social life cycle assessment of palm oil biodiesel: a case study in Jambi Province of Indonesia. *The International Journal of Life Cycle Assessment*, 18(7), 1386-1392.
- Martínez-Blanco, J., Lehmann, A., Muñoz, P., Antón, A., Traverso, M., Rieradevall, J., & Finkbeiner, M. (2014). Application challenges for the social Life Cycle Assessment of fertilizers within life cycle sustainability assessment. *Journal of Cleaner Production*, 69, 34-48.
- Reitingner, C., Dumke, M., Barosevcic, M., & Hillerbrand, R. (2011). A conceptual framework for impact assessment within SLCA. *The International Journal of Life Cycle Assessment*, 16(4), 380-388.
- Revéret, J.-P., Couture, J.-M., & Parent, J. (2015). Socioeconomic LCA of milk production in Canada *Social Life Cycle Assessment* (pp. 25-69): Springer.
- Shen, L.-y., Tam, V. W., Tam, L., & Ji, Y.-b. (2010). Project feasibility study: the key to successful implementation of sustainable and socially responsible construction management practice. *Journal of Cleaner Production*, 18(3), 254-259.
- Traverso, M., Asdrubali, F., Francia, A., & Finkbeiner, M. (2012). Towards life cycle sustainability assessment: an implementation to photovoltaic modules. *The International Journal of Life Cycle Assessment*, 17(8), 1068-1079.
- Valdes-Vasquez, R., & Klotz, L. E. (2012). Social sustainability considerations during planning and design: framework of processes for construction projects. *Journal of construction engineering and management*, 139(1), 80-89.
- Wong, K.-d., & Fan, Q. (2013). Building information modelling (BIM) for sustainable building design. *Facilities*, 31(3/4), 138-157.
- Zhang, X., Wu, Y., & Shen, L. (2015). Embedding “green” in project-based organizations: the way ahead in the construction industry? *Journal of Cleaner Production*, 107, 420-427.

Zhao, Z.-Y., Zhao, X.-J., Davidson, K., & Zuo, J. (2012). A corporate social responsibility indicator system for construction enterprises. *Journal of Cleaner Production*, 29, 277-289.

Zuo, J., Pullen, S., Rameezdeen, R., Bennetts, H., Wang, Y., Mao, G., . . . Duan, H. (2017). Green building evaluation from a life-cycle perspective in Australia: A critical review. *Renewable and Sustainable Energy Reviews*, 70, 358-368.

Zuo, J., & Zhao, Z.-Y. (2014). Green building research—current status and future agenda: A review. *Renewable and Sustainable Energy Reviews*, 30, 271-281.

**Contact email:** [sliu018@e.ntu.edu.sg](mailto:sliu018@e.ntu.edu.sg)

***Recycle of Semarang City Liquid Waste With “Reuse” Consortium of Mangrove Probiotic Bacteria Treatment***

Delianis Pringgenies, University of Diponegoro, Indonesia  
Rini Widiyadmi, Sma Islam Al Azhar 14 Semarang, Indonesia  
Ragil Susilowati, Diponegoro University, Indonesia  
Azahra Aliyyu Denaldo, Sma Islam Al Azhar 14 Semarang, Indonesia  
Muhamad Afwan Shadri Viharyo, Diponegoro University, Indonesia  
Dafit Ariyanto, Asahan University, Indonesia

The Asian Conference on Sustainability, Energy & the Environment 2018  
Official Conference Proceedings

**Abstract**

Statement of the Problem: Reuse bioactivator liquid composter had been produced for liquid waste treatment consist of four probiotic bacteria function as pathogenic antibacteria-agent. Whereas the use of four consortium probiotic bacteria will have a better pathogenic antibacterial activity than only one type. The purpose of the research is to process liquid waste and produce clean water by means of eliminating the number of pathogenic bacteria using a “Reuse” probiotic consortium. Further step is pathogenic bacteria count after treatment and phyto-chemical analysis of the “reuse” product. Methodology & Theoretical Orientation: Reused liquid is added to each waste water sample in 10 and 20 ppm concentration. Observation includes: resulting odor, microbial development, absorbance rate, identification of pathogenic bacteria by morphology, and phytochemical screening of the resulting compounds. The results show that sample with 20 ppm reused water is odorless, with lowered density of pathogenic bacteria population from  $12 \times 10^8$  cell/mL to  $3 \times 10^8$  cell/mL, and lowered absorbance rate from 0.625 nm to 0.225 nm. Staphylococcus Aureus is found to be the most prevalent pathogenic bacteria in the waste water. The microbial consortium is found to produce alkaloid, tannin, and steroid. The formation of inhibition zones is the result of microbial consortium activity against the pathogenic bacteria. Conclusion & Significance: Applied technology of “Reuse” mangrove probiotic bacteria consortium had significantly be able in recycling Semarang city liquid waste to produce clean water.

Keywords: mangrove waste, water waste, bacterial consortium, anti bakterial, identification

**iafor**

The International Academic Forum  
[www.iafor.org](http://www.iafor.org)

## Introduction

The existence of rivers in Semarang city is important for the livelihood of its citizens. As such, the development of building, housing and settlements is supposed to fully use the land in ways that do not damage riverbank areas. Based on the data from Statistics Indonesia (BPS) in 2001, the biggest portion of land use in Semarang City is settlement (33.12%). This shows that the dominant function of land in the city is domestic service. The land use for settlement is spread along the main route, especially near the city center [1].

Healthy environment is a vital part of good healthcare. Unsanitary environment will both indirectly and indirectly impact the health of the people living in it. Clean water is one of the most important means of attaining good health and sanitation. It is difficult, if not impossible altogether, to be healthy and hygienic when the water consumed daily is contaminated by microbes and is turbid, with strong odor and will cause various disease. Consumption of unclean, contaminated water will have adverse effect on the body, such as diarrhea, parasitic infestation, dysentery and cholera. Yet, many people in Semarang still seemingly ignorant toward the impact of these diseases, which can lead to death.

This issue is caused by an uncontrolled population growth and environmental deterioration, creating unpleasant smell and a squatter area in the middle of the city. Contamination of water sources in urban areas is a very harmful situation, since the use of water from the said source can cause disease, yet the community often have limited, with great difficulty if any, access to other clean water supplies. Disease prevention depends highly on individual behavior supported by environmental condition, the availability of infrastructure and support from regulations promoting a healthy lifestyle.

The more people come in, less land become available and the more demand there are for clean water. In addition, rainy season with heavy precipitation causes many areas of Semarang city to flood, further limiting access to clean water. In such condition, the possibility of disease outbreak caused by poor sanitation and hygiene is high. Although there are a number of chemical compounds that can be used in water purification, such as chlorine ( $\text{Cl}_2$ ) or potassium aluminium sulfate ( $\text{KAl}(\text{SO}_4)_2 \cdot 12\text{H}_2\text{O}$ ), excessive and prolonged use of the compounds may pose health risk. Among the identified risk caused by water purification chemicals are skin irritation, sunburn, and compromised immune system.

In site observation at Sekayu urban village showed that in addition to contaminated water from flood, most people in the community had unhealthy sanitation practice by defecating in the river although access to sanitation facilities such as public toilet is widely available. In addition to causing health issues, this unhealthy practice also damages the aesthetics of the area. The fact that the water in Pekunden river often dried up added to the inconvenience in that the feces is not flushed away by the water. The existence of squatter eateries surrounding the river also exacerbate the possibility of outbreak of diseases such as cholera, dysentery, typhoid, parasitic infestation, digestion system diseases, dermal irritation and bacterial poisoning. That Sekayu urban village is located near the city center of Semarang proves that even in the center

of urban area there are still citizens who have unsanitary practices of defecating in the river [2].

In the other hand, the use of marine produce in health products is a viable yet not yet sufficiently explored in Indonesia. The country, of which 80% of its area is covered with bodies of water, is located in the longitude and possess a wealth of flora and fauna; one of which is mangrove. After the Aceh tsunami disaster, coastal mangrove forest rehabilitation has been a prominent agenda of the Indonesian government. In mangrove ecosystem management, mangrove waste has become an issue in need of a solution. A recent study suggests that mangrove waste possess secondary metabolites with active chemical compound which shows viability in health products applications. The active compounds are produced by symbiote microbes which are similar to its host [3].

Based on the narratives mention above, this study is undertaken to see the viability of the application of symbiont microbes found in mangrove waste in water treatment in the area of Semarang city and its immediate vicinity. The basic idea is to obtain purified water which is treated with materials taken from nature, of which side effect is negligible and has compounds that organically breaks down.

Coastal mangrove forest rehabilitation program in Indonesia often face the challenge of mangrove waste management, since many mangrove forest rehabilitation sites do not have a designated waste management site or facilities. The existence of microorganism which is associated with mangrove waste has shown secondary metabolite synthesis activities which is a potential source for the exploration of new chemical compounds. Symbiont microbes of mangrove plants are a colony of microbe which thrives and associates with mangrove waste. These symbiont microbes also contribute in the nutrition cycle for the sustenance of their host and are also useful as waste degradation materials. Chemical compounds produced by symbiont microbes have the potency to be used as precursors for biosynthesis metabolism against pathogenic and other predatory microbes [4]. Isolated microbes from plants with bioactive compounds has been known to exhibit more activity, even more intense than that of their host [5]. Based on the finding, it is assumed that the *Reuse* product in the form of compost bio activator can also be used to purify dirty water to obtain clean, more sanitary water. Four microbe species have been identified in such *Reuse* products, namely *Pseudomonas* sp., *Flavobacterium* sp., *Acinetobacter* sp., *Bacillus subtilis*, all of which are potent antimicrobial agents. When used together in an environment, the microbes reinforce each other and form a microbial consortium which increase the efficiency of breaking down harmful materials during processing. Synergical interaction among microbes in the consortium and with the immediate environment results in an organic break down of pollutants in the water. Based on the narrative, this study aims to provide an organic water purification solution by eliminating harmful microbes in the water, to turn dirty water into water safe for consumption, and to identify pathogenic microbes which causes repugnant odor in the water waste.

## Materials and Methods

Samples were collected from the site and isolation of microbe within the sample was performed.

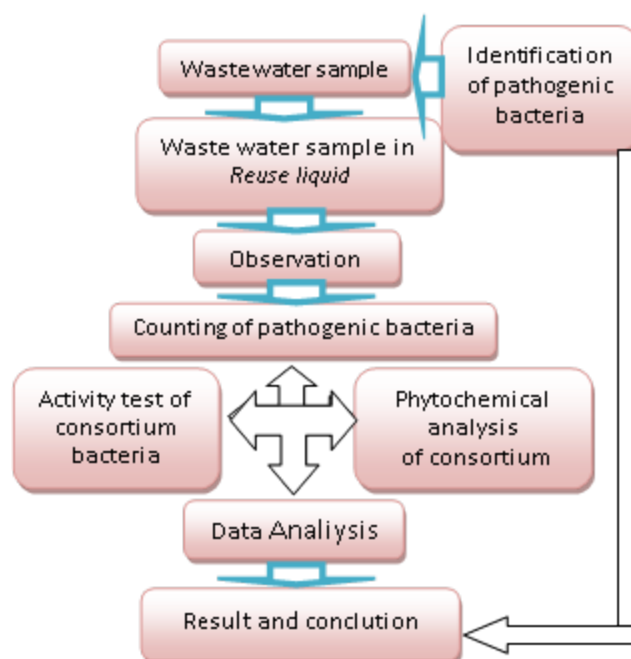

**Figure 1:** Research procedure in the production of purified water using mangrove waste by the use of consortium of symbiont microbes.

Bioactivity screening of consortium microbes, pathogenic microbe cell density measurement, pathogenic microbe identification, and phytochemical screening of consortium microbes were then carried out. Antimicrobial activity of consortium microbe against waterborne pathogenic microbe was carried out according to the method employed in [1], which can be seen in the flow chart above..

## Results and Discussion

### Odor Test Result

The results of *reuse* microbial test showed significant results, as shown in Table 1, that water sample from Pekunden possessed a very strong odor when taken during sampling. *Reuse* microbe from mangrove waste in 20 ppm concentration was added and incubated for one night. This results in elimination of odor in the sample after incubation. Another sample, added with 10 ppm of *reuse* microbe, did not show significant result.

**Table 1:** Results for odor observation of the water samples from all four research sites.

No	Water Sample	Odor
1	Control	Tidak bau
2	Pekunden without treatment	Very strong and pungent
3	Pekunden, 10 ppm treatment	Strong (similar to gutter waste)
4	Bugangan, 10 ppm treatment	Strong
5	Rejosari, 10 ppm treatment	Strong
6	Kaligawe, 10 ppm treatment	Strong
7	Pekunden, 20 ppm treatment	Odorless

### Cell Density and Absorbance Rate Test Results

Water sample from Pekunden before treatment showed  $12 \times 10^8$  cell/ml density with 0.625 absorbance rate. After the the addition of consortium microbe at 20 ppm, a significant drop in cell density to  $3 \times 10^8$  cell/ml with absorbance rate of 0.225 was obtained, as shown in Table 2, Table 3, Table 4, Image 2, and Image 3.

**Table 2:** Cell (microbe) density measurements results of all samples with the addition of consortium microbe from mangrove waste.

No	Sample	Cell density ( $\times 10^8$ sel/ml)
1	Control	0
2	Pekunden without treatment	$12 \times 10^8$
3	Pekunden, 10 ppm treatment	$6 \times 10^8$
4	Bugangan, 10 ppm treatment	$3 \times 10^8$
5	Rejosari, 10 ppm treatment	$9 \times 10^8$
6	Kaligawe, 10 ppm treatment	$6 \times 10^8$
7	Pekunden, 20 ppm treatment	$3 \times 10^8$

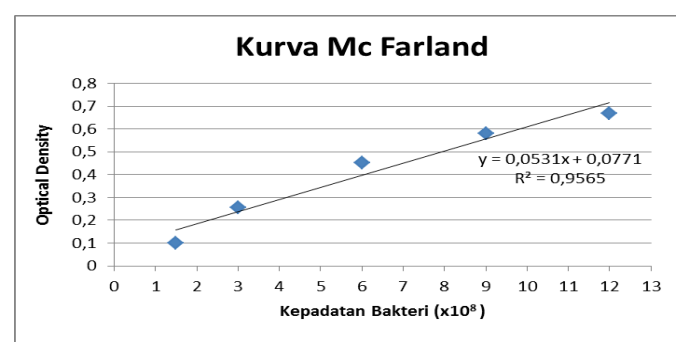
**Figure 2:** Graphic of microbe cell density ( $\times 10^8$  cell/ml)

**Table 3:** Absorbance rate test results of all the samples with the addition of consortium microbe from mangrove waste.

No	Sample	Absorbance Rate ( $\lambda = 600 \text{ nm}$ )
1	Control	0
2	Pekunden without treatment	0.625
3	Pekunden, 10 ppm treatment	0.483
4	Bugangan, 10 ppm treatment	0.307
5	Rejosari, 10 ppm treatment	0.503
6	Kaligawe, 10 ppm treatment	0.436
7	Pekunden, 20 ppm treatment	0.225

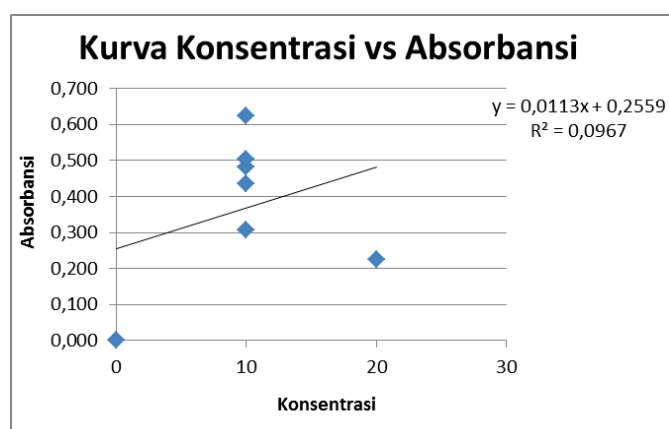
**Figure 3:** Graph representing probiotic concentration relative to absorbance rate.**Table 4:** Microbe cell density ( $\times 10^8$  cell/ml)

Kepadatan Sel ( $\times 10^8$ sel/ml)	OD
1.5	0.100
3	0.257
6	0.451
9	0.582
12	0.669
$y = 0,053x + 0,077$	
0.737	12.453

### Identification of Pathogenic Microbe from Waste Water Sample

By observation, water sample from Pekunden produced the strongest odor of all the samples. The Pekunden sample was then measured for cell density which showed a



very high density of  $12 \times 10^8$  cell/ml. Microbe isolation of the sample identified 16 isolates, of which morphologies can be seen in Table 5.

Gram staining on all three microbe isolates showed purple coloration, which can be concluded that the isolates contained gram positive bacteria from the species *Staphylococcus aureus*.

**Table 5:** Morphology of the identified microbes in Pekunden river water sample

No	Code	Form	Margin	Elevation
1	PK.2.1	Filamentous	Filamentous	Low convex
2	PK.2.2	Irregular	Serreted	Low Convex
3	PK.2.3	Filamentous	Lobate	Low Convex
4	PK.3.1	Circular	Entire	Low Convex
5	PK.3.2	Irregular	Urodate	Low Convex
6	PK.3.3	Punctiform	Entire	Convex
7	PK.3.4	Circular	Entire	Raised
8	PK.3.5	Circular	Entire	Low Convex
9	PK.4.1	Rhizoid	Rhizoid	Umbonate

## Discussion

The strong odor of Pekunden river water sample originated from the thriving pathogenic microbe as a result of degradation of solid and chemical household waste as well as pesticides from agricultural activities. The contaminated river water then seeped into ground water, a source of well water. Pekunden river water sample, without treatment, has been observed to produce a very strong odor with a cell density of  $12 \times 10^8$  cell/ml with an absorbance rate of 0.625. This means that the river water posed a very significant health risk when it seeped into sources of ground water in the vicinity. An addition of *Reuse* microbe in 20 ppm concentration to the water eliminated the odor and lowered cell density in the water to  $3 \times 10^8$  cell /ml with an absorbance rate of 0.225.

During sampling, skin contact with Pekunden river water caused burning sensation and rash (similar to skin irritation caused by direct contact with strong acid), even after washing hands. These sensations felt in the skin epidermis was one of the indicators that the water had been contaminated with pathogenic microbes. Pathogenicity is the ability of any pathogenic agents to cause disease. It covers initiation from the infection process and mechanism in developing disease [6]. This study found that *Staphylococcus aureus* was the most prominent species. *Staphylococcus aureus* is a gram positive species which produces yellow pigmentation, facultative anaerobic, does not produce spore and is not motile. The species commonly develops in pairs or in a colony, with a diameter of 0.8-1.0  $\mu\text{m}$ . *Staphylococcus aureus* thrives in an environment with 37 °C temperature with a

reproduction rate of 0.47 hour. This species is categorized as pyogenic microbe, which means that most disease caused by the species results in purulent local infection. *S. Aureus* produces catalase enzyme, which converts  $H_2O_2$  into  $H_2O$  and  $O_2$ , and coagulase enzyme, which causes fibrin to coagulate and to clot. Coagulation is associated with pathogenicity since the clotting of fibrin caused by this enzyme is accumulated around the bacteria, forming a barrier which restrict the access of host protective agents to the bacteria which hinders phagocytosis process [7].

The activity of *Reuse* liquid microbe comes from 4 species of bacteria namely *Pseudomonas* sp., *Flavobacterium* sp., *Acinetobacter* sp., and *Bacillus subtilis*. These activities together significantly enhance the potency of the liquid against pathogenic microbe. *Bacillus subtilis* shows a specific extracellular activity through protease enzyme. Protease is an enzyme which is capable of hydrolyzing peptide bond in proteins. This enzyme is often distinguished into proteinase and peptidase. Protease catalyzes protein molecule hydrolysis into large fragments, whereas peptidase catalyzes polypeptide fragments into amino acids. Protease is vital in various biological functions, from cell to organism level, in running metabolic reactions dan regulatory functions. *Bacillus subtilisi* has also been known to mitigate the development of pathogenic microbes.

Generally, bacteria work by breaching cell wall integrity, alter cell permeability, convert protein molecules and nucleic acid, disrupt the mechanism of enzymes and hamper synthesis of nucleic acid and proteins [8]. The important targets in the work of antimicrobial agents against gram-positive and gram-negative microbes are ribosome, cytoplasmic membrane, fat biosynthesis enzymes, as well as replication and transcription of DNA. Antimicrobial agents are bacteriolysis in nature against both gram-positive and gram-negative bacteria, they eliminate threat by performing lysis on the cell and extracting its cytoplasmic components. Lysis can lower the number of cells and culture density, as seen in Table 2. Bacteriolythic compound is one of the antibiotic compounds which can prevent cell wall synthesis.

## Conclusion

The study found that the application of biotechnology from consortium microbe found in mangrove waste showed potency in sterilizing pathogenic bacteria in contaminated water. Microbe identification of contaminated water showed *Staphilococcus aureus* as the dominant pathogenic species. Phytochemical screening of consortium microbe showed contents of alkaloid, tannin, and steroid. Antimicrobial activity test of consortium microbe against the pathogenic microbe in the sample resulted in the formation of inhibition zone.

## References

1. Barrow, G. I. and Feltham, R.K.A (1993) Cowan and Stell's Manual For The Identification of Medical Bacteria. Cambridge University Press.pp. 351.
2. Amalina Farah N., Nurjanah, Massudi Suwandi (2014) Perilaku BAB di Sungai Pada Warga di Kelurahan Sekayu Semarang Tahun 2014 (*Skripsi*).
3. Pringgenies D., I. Azmi\*), A. Ridho, R. Idris (2016) Exploration of Bacteria Symbionts Mangrove Waste For The Production of Decomposer. Prosiding International Conference on Coastal Zone, Osaka, Japan May 16 – 18, 2016, June, 2015.
4. Taylor M.W., R. Radax., R. Doris and M. Wagner (2007) Sponge – Associated Microorganisms: Evolution, Ecology, and Biotechnological Potential. Microbiology Reviews. American Society For Microbiology. Washington DC.
5. Kinsky. N.I and E. J. Johnson (2005) Carotenoid Actions And Their Relation to Health and Disease. Moleculae Apects of Medicine. Vol. 26 (6) : 459 – 516. Elsevier.
6. Jawetz, E. et al (1996) Mikrobiologi Klinik. Jakarta : Penerbit Buku Kedokteran. EGC
7. Stewart, F.S (1974) Bigger's Bacteriology and Immunology for Student of Medicine. The English Language Book Society and Bailliere Tindall & Cassell. London.
8. Pelczar dan Chan (2005) Dasar-Dasar mikrobiologi. Jakarta. UI Press.



## *Investigating State of the Sustainable Building Design Parameters*

Reihaneh Aram, Eastern Mediterranean University, Northern Cyprus  
Halil Z. Alibaba, Eastern Mediterranean University, Northern Cyprus

The Asian Conference on Sustainability, Energy & the Environment 2018  
Official Conference Proceedings

### **Abstract**

Sustainability is understood to be the solution to environmental challenges. Sustainable architecture involves an environmentally friendly design, which has a minimum negative effect on the natural environment. Due to the basic environmental pollution caused by energy generation, improving the environmental performance must involve all sustainable building elements throughout design and energy efficiency. The aim of this study is to discuss sustainable building design in the context of green architecture principles, such as Eco-friendly and energy efficiency throughout the building performance. Furthermore, this paper deals with sustainable building performance, which depends on the sustainable design parameters implemented. This is a qualitative study whose methodology is based on descriptive and analytic methods. The discussion part includes comparison, analysis, and general discussion of the relevant information through the literature reviews and document information. This research depicts that building design parameters and building performance were faced with a conceptual revolution by the advent of sustainable buildings systems, even as the sustainability concept influences the occupants. Additionally the concept of the sustainable energy building ideals effect on the human thoughts and lifestyle, which it has contrast with last decades. For instance, in the hot climate, windows blind left open on the south facade of the building throughout summer can contribute to increasing heat gain, as the same time it's vital for having further mechanical cooling. However, if design operable windows in the left open overnights during winter, it would cause useless heating, overall the users have a major role in the whole building energy usage.

Keywords: Sustainable Parameters, Building, Design

**iafor**

The International Academic Forum  
[www.iafor.org](http://www.iafor.org)

## Introduction

Four efficient measurements of sustainable development were proposed at the UN Conference on the Environment and Development in 1992. These measures were: “Agenda 21”; the “climate change convention”, which took the form of an agreement between countries that provided an actionable framework for the reduction of greenhouse gas-related global warming; the “biodiversity convention”; and “the statement of principles”, the primary concerns of which are worldwide forest conservation and sustainable development management (Edwards, 1999).

The concept of sustainability evolved from a primarily environmental consideration into a concern in architectural design, such as space construction, energy volume, economy, and environment. As a concept, sustainability finds its basis in varying environmental, social, and economic viewpoints, and is also affected by the various elements that emerge from the combination of art and technology (Ruzbahani, Shemirani & Ekhlasli 2016). Though complex, the concept of sustainable architecture helps to raise awareness regarding the importance of the planet’s non-human creatures. Humanity’s goal of creating suitable models of living standards that are able to accommodate all its activities without avoidable adverse impacts on the environment is reflected in green, sustainable, and eco-friendly architecture, which have reoriented architectural goals in the direction of greener architecture (Mahdavinejad et al., 2014. Ragheb, El-Shimy & Ragheb 2016).

Energy is a foundational element of the economies, societies, and sustainable development goals of different countries. Modern infrastructural developments have had the effect of making increasing energy demands a serious concern (Shaikh et al., 2017). A United States’ report concluded that a significant percentage (41%) of energy consumption is accounted for by the Building Sector (EIA 2010.Nguyen 2013).

The realization of buildings that embody the principles of sustainable development requires that some methodological considerations regarding the protection of the environment and energy conservation are taken into account. First, the method must be energy efficient and economically practical. Second, the means of measuring energy savings must be beneficial to the environment. Lastly, the method must sufficiently balance current and anticipated environmental requirements and energy needs while simultaneously ensuring the conservation of energy resources and environmental cleanliness. Three building types emerge from the utilization of the three methodological approaches outlined above: environmentally friendly, energy efficient, and sustainable buildings. Energy efficiency, however, is fundamental to the sustainability of any building. Some of the bolder characteristics of energy efficient buildings include an appropriate envelope, suitable thermal properties, heating, adjustable cooling controls, and effective electric systems (Chwieduk, 2003).

The goal of this study is to provide an assessment of the fundamental principles of sustainable architecture as they relate to the consumption of energy, green architecture, passive performance strategies, and the concept of environmental-friendliness with the overall objective of attaining a satisfactory building performance level.

## Literature review

Since the 1970 energy crisis, the sustainable development concept has been intrinsically tied to the problem of environmental pollution. As the 1987 Brundtland Report famously defined it, sustainable development is seen as “the development which is the response to the present requirements without compromise the future generation ability to respond their requirements” (Mao et al., 2009).

The prevalent contemporary understanding of the ‘green building’ is founded in the applications and facilities that emerged from sustainable construction. Such construction aimed at improving the health of occupants, the efficient use of resources, and energy conservation, thus minimizing the adverse impact on the natural environment (Mao et al., 2009). A primary impediment to the implementation of green building is the regulation of the energy used by the building sector in some countries (Shaikh et.al 2017). The desire of the green building sector to increase awareness of sustainable development engendered a corresponding rise in environment-related legislation in various countries. In the European Union (EU), for example, the Building Energy Performance Directive (EPBD) requires that from 2006, every building must receive documentation certifying its energy performance and also satisfy a minimal energy performance principle (EPBD, 2009. Hwang & Tan 2012).

A project sponsored by the OECD argued that sustainable buildings are best understood as buildings, which have an integral quality (economic, environmental, and social) and a minimal degree of impact in the natural environment. The project went further to outline five primary goals of sustainable building, which include: the efficient use of resources, minimizing gas emissions and the efficient use of energy, mitigating pollution, harmonizing the environment, and integrated and systematic approaches (OECD, 2002. Clements & Jeronimidis, 2005).

The Eco-efficiency building is a primary example of sustainable architecture. While such buildings have a variety of definitions, they are all geared towards the same target. The World Business Council of Sustainable Development (WBCSD) defines them as a suitable human quality affordance service despite the competition for human gratification, while minimizing ecological impact and resource consumption, as well as accounting for life-cycle and the WBCSD’s 1992 Earth estimation. As introduced in the 1990s, the concept of sustainability was intended for use as an analytical instrument (Caiado et al., 2017). The principles of sustainable development found in construction sectors, such as the building sector, hold that it is necessary to ensure an appropriate level of performance and functionality while ensuring that adverse environmental impacts are kept at a minimum. This requires, however, that the necessary developments in both the economic and social (cultural) dimensions contribute to standardization on the local and international (global) levels (ISO 2008. Hakkinen & Belloni 2011).

The economic advantages offered by Green buildings center primarily on three business principles: acquisition (initial review, identifying recurring problems), transformation (audits, environmental declaration), and assimilation (LCA, a plan of action and assessable objectives). Additionally, the methods of energy conservation, waste management, enhancing the productivity of occupants, water sources,

maintenance, and operation costs can also be included in the budget (USGBC, 2003. Hwang & Tan 2012).

When assessing building performance, it is imperative that the comfort of the occupants and how they are impacted psychologically by the building are also taken into consideration. In terms of sustainability in the building sector, the overall comfort of the users can both be linked to and defined by thermal comfort. The satisfaction of the occupants thus serves as an efficient factor in determining building performance. While thermal comfort is understood to be a primarily mental condition expressing satisfaction with the thermal environment (ASHRAE standard 55), it can also be defined in terms of energy consumption. In this sense, it concerns the environmental system of the building itself, which is important for the sustainability approach (Yao, Li, & Liu 2009).

In terms of measurement, psychological adaptation is neither simply nor directly quantifiable. It is typically portrayed as a reaction, an altered subjective perception, or sensory information over the duration of a previous thermal experience (De Dear, Brager 2002. Yao, Li, & Liu, 2009). Repeated exposure reduces the sensitivity if the human body to a thermal stimulus, thus relaxing expectations due to a reasonable degree of sensitivity (Frisancho, 1981. Glaser, 1966).

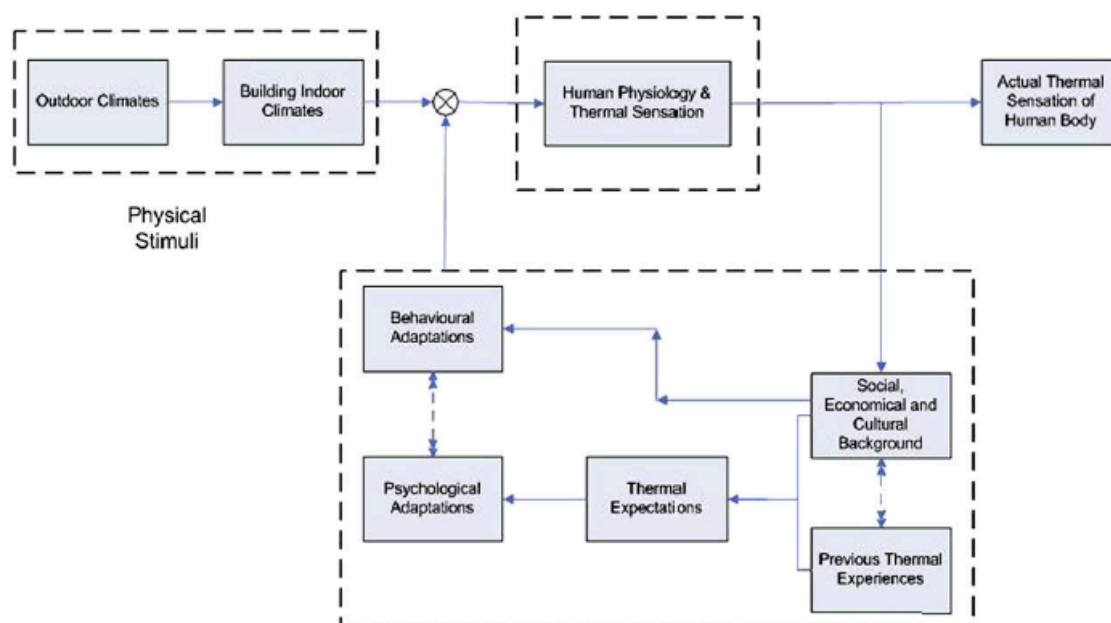

Figure 1: the adaptations thermal comfort mechanism model (Yao, Li, & Liu 2009).

A rival understanding of sustainable architecture as Eco-medical is underpinned by arguments regarding design-specific sustainability concerns, which are geared towards a view of individual health as a humanist and social issue (Isabelle and Lawrence, 1999. Guy & Farmer, 2001). The recognition of the importance of individual health in light of this debate has spurred a growing need for healthy environmental conditions. Legitimate links have been drawn between human health and the influence of factors from the external environment, such as air, water quality, and urban spaces. This relatively novel line of thinking has drawn the attention of medical scholarship to how physical and psychological health problems can result due



to the effects of various built environments (Guy & Farmer 2001). Various studies exploring the efficient use of energy resources have found that artificial lighting and air conditioning directly affect the thermal comfort of the building occupants (Kwong & Ali 2011).

Understood to be a relatively common approach to architecture, sustainability can alternatively be defined as either green design or green architecture. Any definition of green design requires, first, a proper understanding of the different categories of environmentally friendly architecture. The characteristics shared by this type of architecture include: maximal use of the passive solar system, utilizing natural sources of power like solar and wind power, spatial efficiency, recycling old buildings by adapting them to modern use, adequately designed ventilation systems for efficient heating and cooling, energy-efficient lighting and appliance systems, minimizing adverse effects on the environment, the use of local materials like wood and stone, utilizing non-synthetic and non-toxic materials, a water-saving plumbing system, and utilizing architectural salvage. Although not all big green buildings have all of these characteristics, what is uniquely common to their green design is a higher degree of sustainability (Ragheb, El-Shimy & Ragheb, 2016).

#### *Building Energy Performance*

One important consideration in building sustainability concerns the energy consumption of the building, which is intrinsically linked to sustainable development measurements and thus, helps define green architecture. Kothari et al. argue that sustainable development is directly related to energy. Furthermore, renewable energy sources, such as waves, solar, wind, etc., play a vital role in sustainability (Kothari, Tyagi & Pathak, 2010. Ghaffarian et al., 2013).

When evaluating the sustainability dimension of the design of a building system, it is possible to assign ratings based on how well the design satisfies green building criteria or parameters. Different building systems are typically evaluated differently in terms of the relevant sustainability framework or parameters, which are determined by regional variations in environmental conditions and to a lesser degree, cultural differences. It is generally understood that evaluating any particular building system requires that the sustainability parameters applicable to each particular region and environment are identified (Al-Gahtani et al., 2016).

A prominent example, the inspiration for the LEED building came primarily from the occupants, who caused the engineer to take more sustainable design considerations into account. The LEED building embodies a wide variety of sustainability considerations, including: sustainable resources and materials, energy and atmosphere, indoor environment quality, sustainable sites, and water efficiency. The Materials and Resources (MR) group awards points for reductions in extraction, transportation, processing, and destruction of the building, as well as the construction of building materials. The Energy and Atmosphere (EA) sector concerns design efficiency, particularly the utilization of renewable energy sources. Indoor Environment Quality (IEQ) focuses on the improvement of thermal and visual comfort, and air quality. Sustainable Sites (SS) involve the integration of local and regional systems, including the natural system for biodiversity and transport. Lastly, Water Efficiency (WE) concerns the efficient and reduced consumption for both indoor and outdoor usage (Shealy 2016).

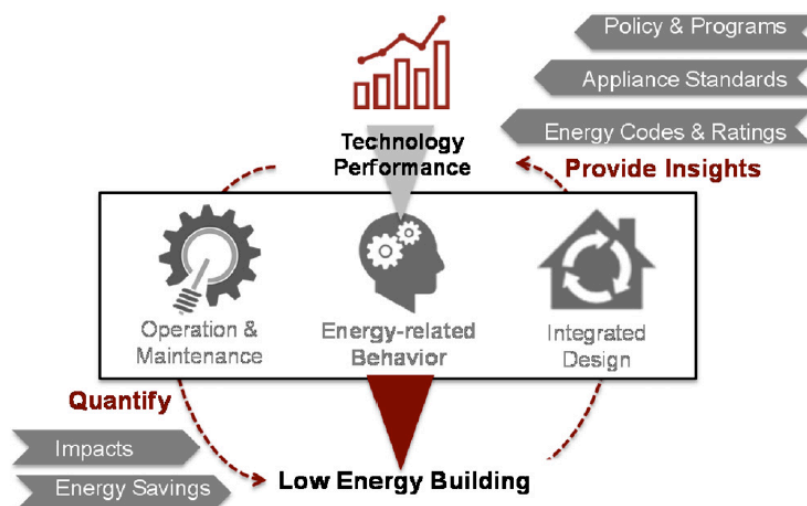

Figure 2: the key factors strategies to low energy building (Hong et.al. 2016).

### *Zero Energy Building*

The Zero Energy Building (ZEB) is a prominent example of green architecture and energy efficiency. The concept guiding the design of such buildings is a realistic solution to the present problems of reducing building energy consumption and minimizing CO<sub>2</sub> emissions, although it is also suited to serving future demands (Lund, Marszal, & Heiselberg, 2011).

A type of Eco-efficiency building, ZEB buildings offer a combination of an energy efficient design with the technical advantages offered by using building equipment to reduce the demand for cooling, heating, and electricity. Additionally, they utilize the on-site generation of renewable energy from solar panels, heat pumps, PV panels, and small micro CHP units (Lund, Marszal, & Heiselberg, 2011). In regards to the social dimension of the sustainability approach, which includes the needs of the users, the energy sources in ZEB buildings produce sufficient energy to satisfy users' demand. Calculating the aggregate building energy sources for ZEB buildings requires that both import and export energy levels are measured to determine the site-to-source energy parameter (Torcellini et al., 2006).

## **Methodology**

### *Descriptive and Analytic Methodology*

This research is primarily qualitative and involves the use of description and analysis to provide a theoretical study. A comprehensive survey was carried out on the sustainable building approaches utilized in various architectural design disciplines, which primarily concern sustainability in terms of environmental concerns. The collection of data for this study was done through a survey of a variety of relevant documents, periodical chapters, and journal articles. Internet websites were also used to aid the description of the systems.

## **Results and Discussions**

A sustainable building can be described in terms of a consideration concept that encompasses a building's entire life cycle, its functional and environmental qualities,

as well as its future value features. In sustainable design, a building should aim at integrating architecture with the electrical, structural, and mechanical engineering resources. It can, however, also include the orientation, shadow, light, proportion scale, texture, and traditional aesthetics of the design, which should be processed while taking the environmental, social, and economic approaches into consideration. As such, the human quality of life element is more important for the building than other considerations (John, Clements & Jeronimidis 2005). Although educating the users can be another important issue. Because by applying some modern sustainable application into the building cannot achieve the high amount of occupants satisfaction and sustainability target whenever they don't know how might use completely.

Nevertheless, according to the public law of Energy policy in 2005, was published that occupants' health and productivity have an effective role in the building performance, however, the building energy efficiency has the same proportion into the building evaluation.

Energy efficient design strategies are commonplace for a variety of building types. Regardless, however, a successful building design strategy depends on user-building interactions.

While passive design strategies, such as those using natural daylighting and ventilation, are much better at minimizing energy consumption, this is not necessarily the case when users are generally uninformed about the operation of the buildings energy-efficiency systems. For example, leaving a window on the building's south façade open throughout a summer day and into the weekend would result in a high heat gain, thus requiring more energy for mechanical cooling. Conversely, leaving design operable windows on the south façade open overnight during winter does not contribute to building heating.

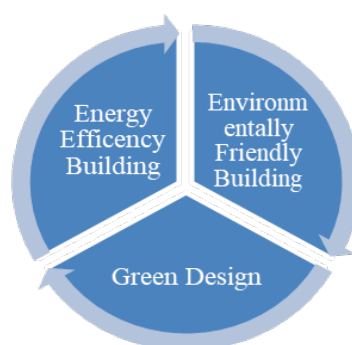

Figure 3: the effective parameters for developing the building performance (source: Author).

To the end of achieving the sustainable energy building, more sustainable designs can be created by taking into account three sustainable architecture approaches. The three architectural approaches protect the relationship between the building construction and the environment, as well as the features of the natural environment. These approaches are the primary and most effective means of realizing sustainable buildings in terms of a clean environment and the use of clean energy. Figure 3 illustrates how the circular relationship between energy efficiency building,

environmental building, and green design is vital to the realization of the goal of a sustainable building.

As common sustainable building design can mention the ZEB or Net Zero buildings. Also, these type of building turns to be popular in many countries. Such buildings are particularly remarkable in that they have been satisfactorily successful in terms of energy efficiency, as well as in regards to their adherence to the parameters of sustainable development.

A directive from the European Union dealing with the energy performance of buildings requires that all new buildings must be either zero or near zero energy buildings by the end of the decade (EPBD, 2010).

The controversial issue about the ZEB or Net Zero buildings according to economic sustainability is it's not affordable for everyone so it needs to investment by some companies so the users are not satisfied with their payment. However, of course, this sort of payments have to circulate investment throughout longterm.

Similarly, the USA's Department of Energy's (DOE) buildings technologies program is working towards the provision of viable zero energy homes by 2020 and zero energy commercial buildings by 2025, although realizing such a level of standardization might prove difficult regardless of these specifications (Sartori, Napolitano & Voss 2012). Sustainability rating systems are particularly important to the goal of achieving sustainable building through the promotion of suitable architectural designs, methods, and construction. (Hu, Cunningham, & Gilloran, 2017).

Masoso and Grobler (2010) argue that less energy is used during working hours (44%), opposed to non-working hours (56%). They argue that this is due primarily to a tendency for lights and equipment to be left running at the end of the workday (Masoso & Grobler, 2010; Day and Gunderson, 2015). These findings illustrate the importance of educating users on the necessity of certain lifestyle changes if there is any hope of ensuring that their actions support the principles of sustainability.

In terms of the economic aspect of sustainability, how clients perceive different market aspects determines how green buildings are economically assessed. The corresponding economic costs for the potential environmental benefits of a sustainable (green) building are determined by the criteria found in the Green Building Index (GBI), which include: 1. Water Efficiency (WE), 2. Innovation (IN), 3. Sustainable Management and Site Planning (MS), 4. Materials and Resources (MR), 5. Energy Efficiency (EE), and 6. Internal Environmental Quality (EQ). The six GBI criteria outlined above are useful in improving the design of any building. Water Efficiency (WE), for example, involves the harvesting and use of suitable rainwater, as well as water saving and recycling in sustainable buildings. In terms of Innovation (IN), innovative and creative design parameters help in successfully satisfying the objectives outlined by the green buildings index. In terms of Suitable Management and Site Planning (MS), the building and the site should be planned in such a way that affords them the best opportunity to access open spaces, landscapes, and public transportation while simultaneously ensuring the conservation of environmentally sensitive spaces and circumventing unnecessarily inconvenient

construction. Materials and Resources (MR) requires the use materials that are recycled or environmentally sensitive, as well as properly managing and storing waste and utilizing recyclable and reusable waste materials. In terms of Energy Efficiency (EE), a building can be made more energy efficient through the use of renewable energy resources, using the building envelope to minimize solar heat gain, daylight harvesting, and ultimately by developing the energy consumption of the building by finding the optimal orientation. Improving the indoor performance of the building involves optimizing visual comfort, thermal comfort, air quality, and internal acoustic (Halil, et al., 2016). Hereby the remarkable point is how can manage and combine all of the GBI criteria into a building. As the economic sustainable issue, how much these parameters can be affordable by the building owners.

One practical example of utilizing sustainable building parameters involves utilizing sustainable criteria in the selection of materials. The important material selection factors are pollution, minimum embodied energy, waste, and energy consumption, which directly increase environmental burdens. The choice of construction material also affects sustainability in the social and economic dimensions, although largely indirectly. Overall, this novel approach to sustainability led to the development of the green materials index, an adequate and fitting solution to sustainable building. Additionally, this sort of materials selection is useful in improving the sustainability rankings of building systems (Khoshnava, et al., 2016). As an example Iranian vernacular materials as a sustainable environmental solution for rural spaces, however, it can be a permanent solution for modern architecture if it is affordable and accessible. According to the architectural design view, the achievable point of the traditional Iranian sustainable can figure out that architectural building such as dome, windward, central courtyard and shading devices can act as environmentally friendly and with the same concept of green architecture. also these spaces can act energy efficiency without any negative environmental effects.

For instance, in the south of Iran which it has the hot and humid climate, there is traditional useful architectural design. One of the common sustainable design parameters is ventilation- shaft or windward. This element can cause thermal comfort according to the microclimate and be parallel with the sustainable architectural concept. It means that by building these elements having the energy efficiency design, environmentally friendly and green architectural building. In contrast with the modern building design which applied in these areas. In this sort of building caused a high amount of the energy usage, however, tried to build eco-friendly buildings. But as users view it generate some issues.

## **Conclusion**

The concept of sustainable buildings revolutionized the kinds of designs found in the building sector. Sustainability ideals also affect the lifestyle and thoughts of the human user. The targets set by sustainability parameters have a significant impact regardless of the particular methodology, which can range from simple to complex. Particularly important is how sufficient a particular method is to meet economic, environmental, and social requirements. A collective human awareness of the diverse and harmful changes occurring in the Earth's ecosystem has redirected attention to the environment, particularly its physical and mental effects on the planet's inhabitants.

This is the origin of the broad and complex concept of sustainability, which is remarkably being applied in the design of architectural products.

A variety of systems can be used in architectural design to satisfy sustainability parameters. Examples of such systems include the fuel cell, passive design elementarily strategy, recycling material, wind turbine generation, roof garden system, geothermal energy generation, and photovoltaic solar panels. The benefits of these systems significantly outweigh their potential costs and they can be used to improve users' indoor comfort with only minimal environmental impact.

On the other end of the spectrum, ensuring users' comfort in buildings typically requires the expensive use of resources by mechanical and electrical equipment and when these resources are depleted, building equipment stops working. As such, a constant move towards sustainability is required for the continued wellbeing of human beings. In light of this, there is a growing trend towards the use of renewable energy sources, including solar, hydro, and wind energy systems.

In conclusion, there is an overall increase in the number of building systems that utilize the sustainable parameters mentioned in this study. The increasing prevalence of sustainable architecture in modern architectural practices signified an equally increasing environmental sensitivity relative to other sustainability dimensions where building performance is concerned, particular in terms of energy consumption. Regardless, it is also necessary to take other physical aspects into consideration, such as the design and performance of the building, as well as their psychological effect on the users.

## References

- Akbulut, M. T., Akbulut, D. E., & Oral, G. K. The Parameters Effect on Sustainable Built Environment Design. 1st International CIB Endorsed METU Postgraduate Conference Built Environment & Information Technologies, Ankara, 2006.
- Al-Gahtani, K., Alsulaihi, I., El-Hawary, M., & Marzouk, M. (2016). Investigating sustainability parameters of administrative buildings in Saudi Arabia. *Technological Forecasting and Social Change*, 105, 41-48.
- Caiado, R. G. G., de Freitas Dias, R., Mattos, L. V., Quelhas, O. L. G., & Leal Filho, W. (2017). Towards sustainable development from the perspective of the eco-efficiency-A systematic literature review. *Journal of Cleaner Production*, 165, 890-904.
- Chwieduk, D. (2003). Towards sustainable-energy buildings. *Applied Energy*, 76(1), 211-217.
- De Dear, R. J., & Brager, G. S. (2002). Thermal comfort in naturally ventilated buildings: revisions to ASHRAE Standard 55. *Energy and buildings*, 34(6), 549-561.
- Day, J. K., & Gunderson, D. E. (2015). Understanding high performance buildings: The link between occupant knowledge of passive design systems, corresponding behaviors, occupant comfort and environmental satisfaction. *Building and Environment*, 84, 114-124.
- EPBD recast, Directive 2010/31/EU of the European Parliament and of the Council of 19 May 2010 on the energy performance of buildings (recast), Official Journal of the European Union, (2010) 18/06/2010.
- Energy Policy Act of 2005, public law 109-058, section 914 EPA Overview of greenhouse gases. 2013. Retrieved from, <http://www.epa.gov/climatechange/ghgemissionsgases.html>.
- EIA, Annual Energy Review 2010, Annual report, The World Business Council for Sustainable Development, October 2011.
- Edwards, B. (1999). Sustainable architecture: European directives and building design. Butterworth Architecture.
- Energy Performance of Buildings Directive (EPBD). 2009. Concerted Action – Energy Performance of Buildings Directive. EU EPBD. <http://www.epbd-ca.org/>.
- Frisancho AR. Human adaptation. University of Michigan Press; 1981.
- Glaser E. The physiological basis of habituation. London: O.U.P.; 1966.
- Guy, S., & Farmer, G. (2001). Reinterpreting sustainable architecture: the place of technology. *Journal of Architectural Education*, 54(3), 140-148.

- Hong, T., Taylor-Lange, S. C., D'Oca, S., Yan, D., & Corgnati, S. P. (2016). Advances in research and applications of energy-related occupant behavior in buildings. *Energy and Buildings*, 116, 694-702.
- Hu, M., Cunningham, P., & Gilloran, S. (2017). Sustainable design rating system comparison using a life-cycle methodology. *Building and Environment*, 126, 410-421.
- Halil, F. M., Nasir, N. M., Hassan, A. A., & Shukur, A. S. (2016). Feasibility Study and Economic Assessment in Green Building Projects. *Procedia-Social and Behavioral Sciences*, 222, 56-64.
- Ghaffarian Hoseini, A., Dahlan, N. D., Berardi, U., GhaffarianHoseini, A., Makaremi, N., & GhaffarianHoseini, M. (2013). Sustainable energy performances of green buildings: A review of current theories, implementations and challenges. *Renewable and Sustainable Energy Reviews*, 25, 1-17.
- Hwang, B. G., & Tan, J. S. (2012). Green building project management: obstacles and solutions for sustainable development. *Sustainable development*, 20(5), 335-349.
- Hakkinen, T., & Belloni, K. (2011). Barriers and drivers for sustainable building. *Building Research & Information*, 39(3), 239-255.
- International Organization for Standardization (ISO) (2008) ISO 15392. 2008-05-01. Sustainability in Building Construction – General Principles, ISO, Geneva.
- Isabelle Lanthier and Lawrence Olivier, "The Construction of Environmental Awareness," in Eric Darier, ed., *Discourses of the Environment* (Oxford: Blackwell, 1999), p. 65.
- John, G., Clements-Croome, D., & Jeronimidis, G. (2005). Sustainable building solutions: a review of lessons from the natural world. *Building and environment*, 40(3), 319-328.
- Kothari, R., Tyagi, V. V., & Pathak, A. (2010). Waste-to-energy: A way from renewable energy sources to sustainable development. *Renewable and Sustainable Energy Reviews*, 14(9), 3164-3170.
- Komurlu, R., Arditi, D., & Gurgun, A. P. (2015). Energy and atmosphere standards for sustainable design and construction in different countries. *Energy and Buildings*, 90, 156-165.
- Khoshnava, S. M., Rostami, R., Valipour, A., Ismail, M., & Rahmat, A. R. (2016). Rank of green building material criteria based on the three pillars of sustainability using the hybrid multi criteria decision making method. *Journal of Cleaner Production*, 173: 82-99.
- Kwong, Q. J., & Ali, Y. (2011). A review of energy efficiency potentials in tropical buildings—Perspective of enclosed common areas. *Renewable and Sustainable Energy Reviews*, 15(9), 4548-4553.
- Lund, H., Marszal, A., & Heiselberg, P. (2011). Zero energy buildings and mismatch compensation factors. *Energy and Buildings*, 43(7), 1646-1654.



Mahdavinejad, M., Zia, A., Larki, A. N., Ghanavati, S., & Elmi, N. (2014). Dilemma of green and pseudo green architecture based on LEED norms in case of developing countries. *International Journal of Sustainable Built Environment*, 3(2), 235-246.

Masoso, O. T., & Grobler, L. J. (2010). The dark side of occupants' behaviour on building energy use. *Energy and buildings*, 42(2), 173-177.

Mao, X., Lu, H., & Li, Q. (2009, September). A comparison study of mainstream sustainable/green building rating tools in the world. In *Management and Service Science, 2009. MASS'09. International Conference on* (pp. 1-5). IEEE.

Nguyen, T. A., & Aiello, M. (2013). Energy intelligent buildings based on user activity: A survey. *Energy and buildings*, 56, 244-257.

OECD. Design of sustainable building policies. Paris: OECD; <http://www.uea.ac.uk/env/>; 2002.

Ragheb, A., El-Shimy, H., & Ragheb, G. (2016). Green architecture: a concept of sustainability. *Procedia-Social and Behavioral Sciences*, 216, 778-787.

Ruzbahani, N. A., Shemirani, S. M. M., & Ekhlasi, A. (2016). Sustainable Tectonics: a conceptual framework to formulate formal structure of sustainable designs.

Sartori, I., Napolitano, A., & Voss, K. (2012). Net zero energy buildings: A consistent definition framework. *Energy and buildings*, 48, 220-232.

Standard, A. S. H. R. A. E. (2010). Standard 55-2010: "Thermal Environmental Conditions for Human Occupancy"; ASHRAE. Atlanta USA.

Shealy, T. (2016). Do sustainable buildings inspire more sustainable buildings?. *Procedia Engineering*, 145, 412-419.

Shaikh, P. H., Nor, N. B. M., Sahito, A. A., Nallagownden, P., Elamvazuthi, I., & Shaikh, M. S. (2017). Building energy for sustainable development in Malaysia: A review. *Renewable and Sustainable Energy Reviews*, 75, 1392-1403.

Trusty, W. (2009). Standards versus recommended practice: separating process and prescriptive measures from building performance. In *Common Ground, Consensus Building and Continual Improvement: International Standards and Sustainable Building*. ASTM International.

Torcellini, P., Pless, S., Deru, M., & Crawley, D. (2006). Zero energy buildings: a critical look at the definition. National Renewable Energy Laboratory and Department of Energy, US.

US Green Building Council (USGBC). 2003. Green Building Costs and Financial Benefits. *Capital E*. <http://www.usgbc.org/Docs/News/News477>.

Yao, R., Li, B., & Liu, J. (2009). A theoretical adaptive model of thermal comfort–Adaptive Predicted Mean Vote (a PMV). *Building and environment*, 44(10), 2089-2096.

**Contact emails:** aireen1371@gmail.com, halil.alibaba@emu.edu.tr

***Research on Photovoltaic Power Generations Installed in Veranda of  
Apartment Houses***

Keiju Matsui, Minna-denryoku Inc., Japan  
Eiji Oishi, Minna-denryoku Inc., Japan  
Mikio Yasubayashi, Chubu University, Japan  
Masayoshi Umeno, Chubu University, Japan  
Masaru Hasegawa, Chubu University, Japan

The Asian Conference on Sustainability, Energy & the Environment 2018  
Official Conference Proceedings

**Abstract**

The usage of the renewable energies is expected to be able to mitigate the energy problem. The application of renewable energy including photovoltaic power generation-PVG has been accepted and spread widely. Various innovative power conditioning systems for PVG have been also studied. In domestic utilization, the actual application of such solar panels is almost installed on top of the roof of the detached house. However, some residents living in the apartment house are having a fairly strong desire to contribute for energy saving due to natural energy generation. The generating power of such case is fairly reduced, so the system construction should be balanced with the reduced power. Thus, it is necessary to improve the construction toward simple one. In this paper, in order to give a reply, simple and concise photovoltaic power generating system having innovative power conditioner are proposed and examined. Considering fairly reduced generation power and narrow space of veranda for installation, the system constructions should be simple and concise. The system construction which gratified their wishes are presented and discussed. These solar panels can be easily connected like usual home appliances having attached plug for connection. Simple system circuit and construction will be presented and discussed.

**Keywords:** Veranda solar, PV power generation, Power conditioners, PVS, Solar panel, Flexible solar panel, Crystal solar panel, Organic thin film, Photovoltaic power, Power converter

**iafor**

The International Academic Forum  
[www.iafor.org](http://www.iafor.org)

## Introduction

Various types of utility-interactive photovoltaic power generations have been reported and accepted widely. Some papers about power converters that interface between photovoltaic arrays and ac utility system have been also reported. Such innovative conditioning systems have been also studied. The actual application of such solar panel is almost installed on top of the roof of the detached house. However, some residents living in the apartment houses are having a fairly strong desire to contribute for energy saving due to natural energy generation. In this study, in order to give a reply, a simple and concise photovoltaic power generation system is to be presented and discussed which is installed in apartment house having verandas with the total power generation capacity of 8~24GW depending on PV panels all over Japan. Considering fairly reduced generation power and narrow space of installation, the system constructions should be simple and concise. In this study, the circuit which gratified their wishes are presented. These solar panels can be easily connected like usual home appliances having attached plug for connection. For reverse power flows and increasing harmonics, their protection circuits must be installed in the input power line if it is necessary. System circuit and their sophisticated construction will be presented and discussed.

In such discussions, there are many subjects to be solved to utilize the PV power in utility interactive power generation. Even more, various safeguard equipment required according to regulations make the cost increase. Thus, it is required to obtain even more low cost PCS. In an extremely lower capacity PCS like proposed one, a way of handling would be different compared to conventional ones. In such case of reduced generating power, quantities of reversed power to the power system would be small, where another mitigated regulation or deregulation would be approved. Thus, in such photovoltaic power generation systems, there are so many subjects to be resolved.

Under such circumstance accepted by electrical utility industry as recognitions and assessments for renewable energy, spread of application is strongly sustained by financial supports of public organizations, and a lot of consumers are hoping to install such photovoltaic power generation system. For ordinary homes, installation of solar panel is restricted to house having roof. However, a lot of residents wish to install the PV panel under supports by public finance. In addition, there are many residents living in the apartment house who wish to contribute the environmental improvement by means of renewable power generation such as PV generation.

In the present situation, however, there is no scheme to perform these requirements subject to such residents. This study is to reply such wishes of residences making contributions by renewable energies.

The specifications for PV panel according to installed place and installed configuration were discussed. According to efficiency of power generation, weight of panel, flexibility and cost of generation, optimum method is to be resolved. The PV panel for veranda solar is installed in narrow veranda

where panel should be arranged in well view point from appearance. As for satisfied solar panel, flexible amorphous Si solar panel, organic solar panel and Si hetero junction (crystal-amorphous) solar cell are fitted for these requirements. Among them, it can be seen that the organic solar cell is the best choice with regard to cost performance. With comparing various solar cells, the characteristic of converting efficiency vs. energy pay back time was resolved and discussed. Under such researches, we can obtain a resolution that the organic solar cell is most prospective one, because in 2020 (Tokyo Olympic year), the lowest power generation cost of 18.10 yen/kWh compared with Tokyo Electric Power Co. cost of 25 yen/kWh can be expected superb features with regard to flexibility, light weight and good design.

### **Research for Installed Scale of Veranda Solar**

Fig.1 shows results from “Statistical Handbook of Japan 2015”, which represents community apartments are totally 22.09 million houses in Japan. The percentage against the total residences in Japan is gradually increasing finally to reach at 42.4% in 2013. As it is expected to continue to be increasing, the needs for veranda solar for community type houses would be increased. As a matter of course, for the community house having veranda with sufficient power by solar, it is required for the sunlight sufficiently to shine in the direction of the south or not to be blocked by obstructions.

In this research project, in order to derive the number of community houses, which is expected to be able to have veranda solar, some researches have been executed. For a case of two panels of 1.2 m<sup>2</sup>, 44.18 million sheets of panel that is 53.02 million m<sup>2</sup> will be installed in verandas over the country. For a case of 200W panel, 8.8 GW power can be totally expected.

### **Hearing results for dummy samplings**

Under considering for installation at veranda. The hearing research have been executed, for flexible panel (Fig.2) and crystal panel (Fig.3). Through over the hearing, an ideal appearance of setting as veranda solar or specifications of the products for users could be made clear, in which the users want to install. Hearing situations are as follows;

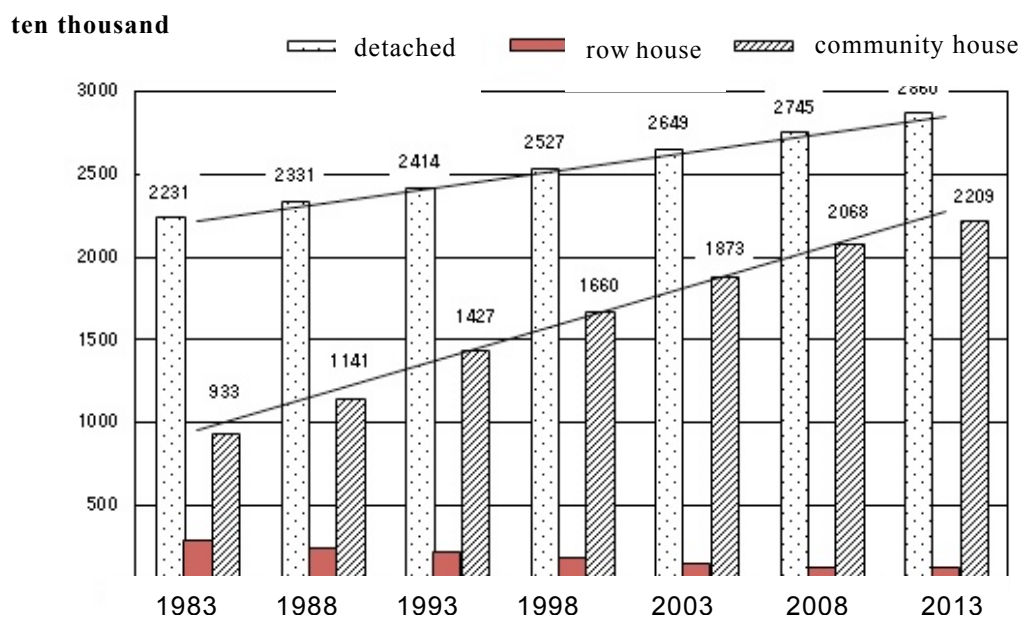

Fig.1. Transition on sort of houses in Japan from “Statistical Handbook of Japan 2015”

(Q.) Which do you prefer flexible type which is light weight and well design characteristic, or crystal type which is high cost, but large power generation ?

(A) Crystal type is 25%. As fixing situation is good stable, higher power is delightful and it js easy to stand against a wall.

Flexible type is 65%. As the cost performance is superior. It is easy to handle even for women. Design performance is superior. It can be put back in a compact way when disuse.

(Q) What for do you use the generated power?

(A) Smart phone, Tablet, Television set, Lap top PC, Gaming machine.

(Q) When do you use mainly?

(A1) The 30% person uses on weekday.

Because on holiday, they are hanging out the laundry, or want to let in the sunshine, so they want to make the power generate while not at home.

(Q) Do you install even for a case of higher cost than power charge of electric company.

(A) Yes is 20%. No is 40%. Dependence on design is 40%.

Under such descriptions, as a kind of solar batteries, the expectation for flexible type gets a majority. As compared to crystal type, accepted reasons are lower cost, light weight, easy treating and good design. In addition, they said, it is satisfied to be able to supply the small power appliance. As for the cost performance, when the power charge in veranda solar becomes higher compared to the electric company cost, they do not want to install, but it depends on their design performance. These are majority opinions.

They seem to want to install the PVG system if the design like flexible type is superior compared to the conventional crystal type. From these hearing results, it can be seen that the promising PV system is that power charge is lower than the one of power company and in addition having good design.

### **Specifications for Veranda Solar**

As the veranda space is narrow, so the generating power is restricted. Consequently further strict cost performance is required. Under such conditions for PV system installed in veranda, suitable indoors wiring, simple power conditioner will be discussed and reported.

### **Circuit Configurations of PCS (Power Conditioners)**

The veranda solar under discussion is that the generating power is small, so suitable PCS should be adopted compared to kW type PCS.

Because the cost of PCS cannot be reduced in proportion to the capacity reduction, the cost reduction is one of the most important objective to attain. Until now, there is little attempt to report a novel circuit itself with lower cost configuration, because the circuit configuration itself is very simple and it seems to be no room to improve the circuit. For large scale PCS with kW type, full bridge circuit is used for like ac motor control, which has many switching devices accompanied boost chopper. Such configuration brings high cost performance. In order to improve such conditions, a novel forward converter type is devised and discussed. In general, almost small scale converters are constructed by forward converters, so the circuit construction know-how and the like is established. And also, the mass production brings lower cost performance. In this research, among three circuit configurations, which are not used for PCS till now, will be discussed, so suitable characteristics and requirements will be made clear. These will be accepted according to their costs and efficiencies which is presented at the bottom in this chapter.

### **PCS by Forward Converter**

Fig.2 shows the first presented PCS. From the dc source, the power with full wave rectified waveform is supplied and synchronized with commercial frequency of ac power supply. By means of inverter of commercial frequency, the dc power is converted to sinusoidal current. The dc power of primary circuit is translated to secondary circuit by single switch of forward converter[1]. The trouble current by abnormality of PV panel side is prevented by insulation transformer. By mean of use of transformer, the secondary circuit voltage can be boosted easily, because the primary voltage of solar panel side is usually lower voltage. This is superior characteristic, in which secondary voltage can be easily boosted by changing the turn ratio. The operation is performed as follows; When the main switch  $Q_m$  is turned on, the current flows through the primary winding ①. In the secondary winding, the current flows through secondary winding ②, diode  $D_2$ , inductor  $L_o$ , and the inverter circuit, where the current flows through IGBTs  $Q_1$ ,  $Q_2$  or  $Q_3$ ,  $Q_4$ .

When  $Q_m$  is turned off, the current flows through the flywheel diode  $D_4$  towards ac power supply of inverter. The winding ③ is used for  $Q_m$  off period, when the stored energy in the core is discharged. As the waveform control method, the pulse width of sinusoidal wave is controlled by  $Q_m$ , while  $Q_1$  to  $Q_4$  are used for low frequency switching. The above mentioned utility interactive control is used for simple PCS as PV power generation, which is used for residential use of 3kW PV power generation system[1] having 92% efficiency. The forward converter is used up to several hundred watt, but in this case of 3kW PCS, higher efficiency can be obtained. The PCS of concerning veranda solar uses 200W/sheet and the like, which is provided in mass product, so there are rich of know-how at manufacturing. Even though it is very simple construction, the total efficiency is fairly high. A original lossless snubber is installed, which is very simple and suitable for this circuit.

### **Center tapped Type PCS**

Fig.3 shows the original circuit proposed by Isao Takahashi[2]. Fig.4 shows the circuit construction proposed by one of the authors[3]. The PCS under discussion can be realized in small size of outer box. In the case of Takahashi, the outer size is thickness 10.0mm, height×width 85×115mm. It uses high frequency transformer whose operating frequency is 90kHz. The external form of the box is suitable for attached on the back board of PV panel. The selection for these three methods can be performed according to those priorities of the efficiency and the cost. With comparison between Fig.3 and Fig.4, though the construction is a little different, the efficiency is almost the same.



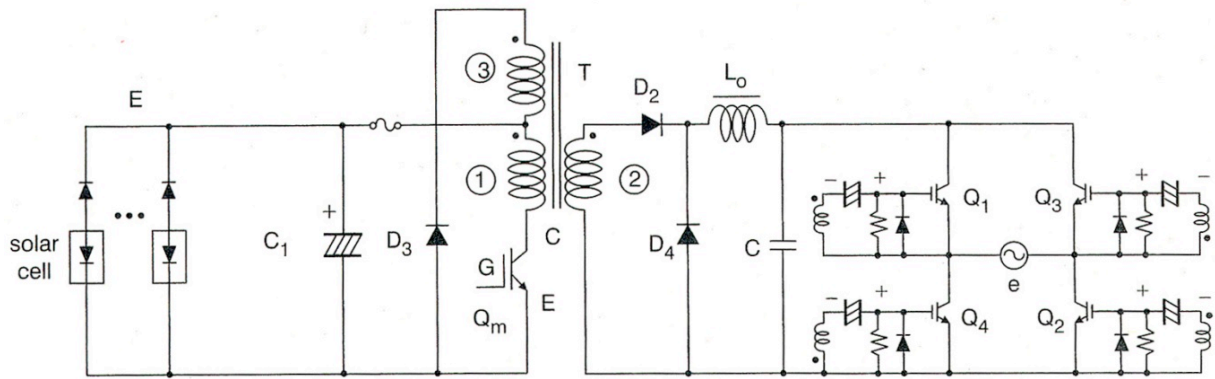

Fig.2. Power Conditioner by Forward Converter with Single Switch Type.

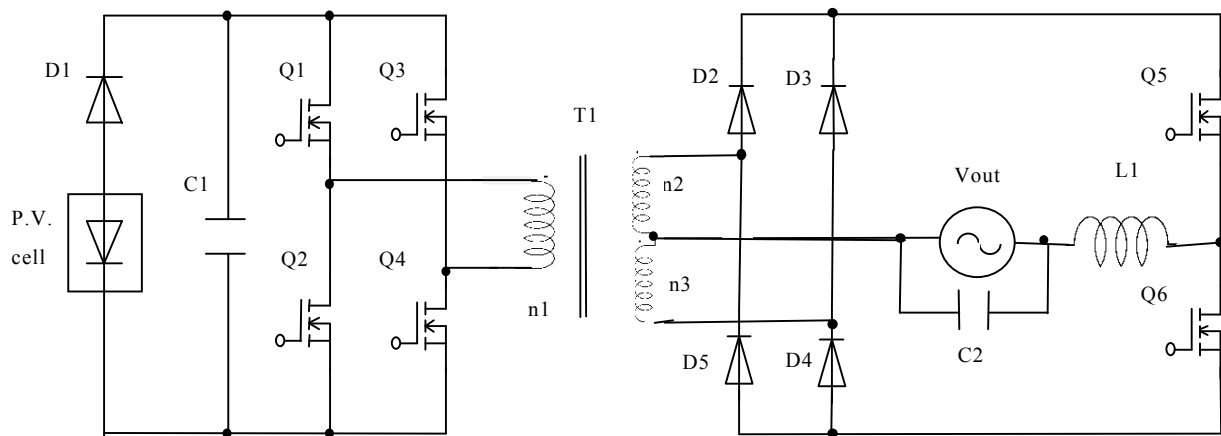

Fig.3. Power Conditioner by Forward Converter with Center tapped

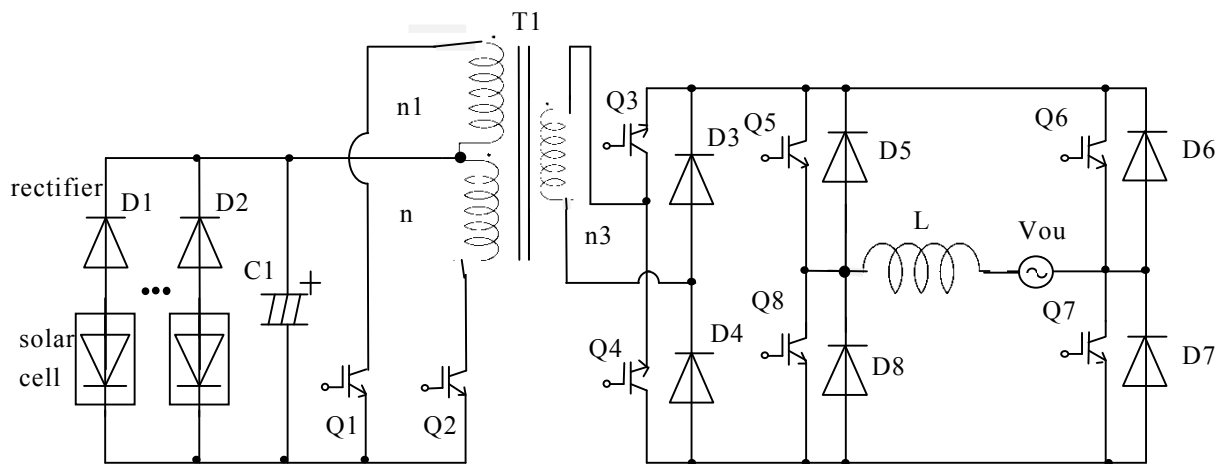

Fig.4. Power Conditioner by Forward Converter with Double Switches Type<sup>(3)</sup>.

Table1. Comparison and Characteristics

Circuit strategy	Characteristics and advantages	Disadvantages
Forward converter[1]	Preventing of dc flow. easy to boost voltage Unified chopper and inverter Single high frequency switch (HFSW) Easy control	Large transformer  Double voltage for HFSW Many number of LFSW
Center tapped converter [2]	Preventing dc flow out. easy to boost volt. Smaller transformer Unified chopper and inverter Small number of low frequency switches (LFSW)	Many number of HFSW Complicated control
Center tapped forward converter by double switches [3]	Preventing dc flow out. easy to boost volt. Smaller transformer  Unified chopper and inverter Small number of HFSW	Complicated control  Large number of LFSW

### Characteristics of this System

Among discussed panels for veranda solar, possible product is to be selected and presented in this research.

- The generated power by solar panel is converted to utility ac 100V network, by which usual home appliances can be used in conventional way.
- The generated power by solar panel is stored in the battery, which is used in the night or all the day.
- When the stored power of the battery is disappeared, it is switched to ac utility network, by which the electric appliances in current use can be supplied continuously.
- The installation operation is easy, that is only simple way to connect by plugs.
- The necessary power can be obtained by outlet on the accommodation box.

### Discussion on Solar Panel

#### Flexible Type

As a flexible type solar panel, the amorphous silicon and organic thin film are treated. Assuming a generating power efficiency of 8% in five years later, 400W power at maximum can be generated for 5m<sup>2</sup> space at veranda. As comparing between amorphous silicon and organic thin film solar panel, it is different in the cost of module, the power generating cost is 21.20 yen/kWh

for amorphous silicon and 18.10 yen/kWh for organic thin film solar panel.

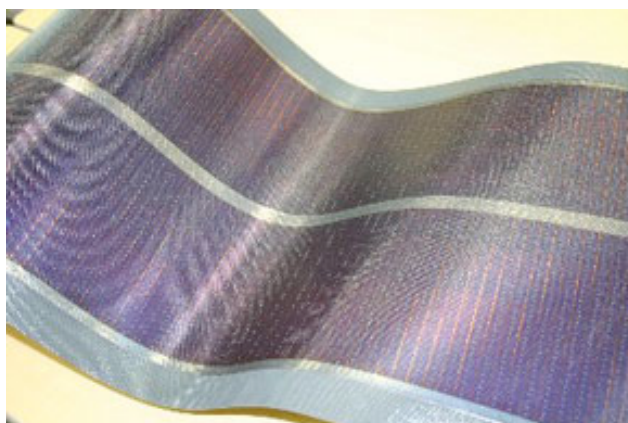

Fig.5. Amorphous Silicon Solar Panel.

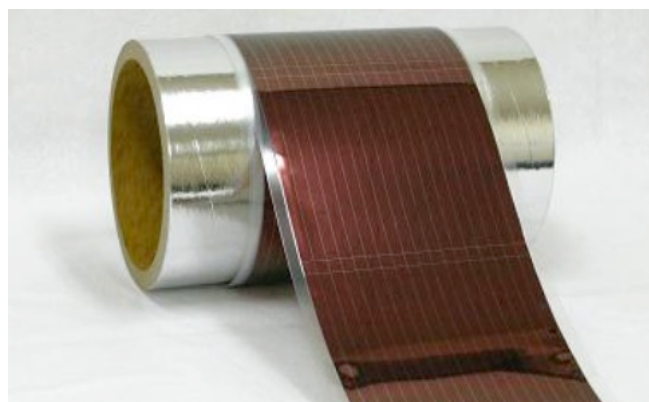

Fig.6. Organic Thin Film Solar Cell.

### Crystal Type

For solar panel of crystal type, hetero junction solar cell (HIT) is treated. Assumed power efficiency  $\eta$  is 22%, the generating power is 1,100W for 5m<sup>2</sup> panel. The power generating cost is 20.07 yen/kWh for ten year operation. As mentioned above of comparing to usual utility network charge in five years later, the charge of veranda solar is estimated to be reduced compared to present 25.91yen/kWh. The veranda solar by crystal type, amorphous silicon, or flexible organic thin type will be realized.

### Conclusions

Through this research, an adequate and possible installation method as veranda solar have been reported and discussed, which have been not introduced widely. As a whole installation scale, if such veranda solar are installed all over Japan, where additional 44.18 million sheets/53.02m<sup>2</sup> are installed still more, which is 8% efficiency of flexible type, 4.24GW at maximum could be obtained. If 22% efficiency of crystal type is installed, 11.7 GW at maximum could be realized as a veranda solar. Furthermore, by means of devising the installment method at verandas, 8.8GW can be expected by using flexible type of 8% efficiency, or 24.3GW can be expected by using crystal type.

On the base of hearing result that the power generation cost due to veranda solar is cheaper than by electric company, various types of solar panels are proposed according to users' needs. The feature of proposed PCS systems is to pursue a lower cost one including the construction cost. According to reducing the capacity, the cost of solar panel is reducing in proportion. The cost of PCS, however, is not reduced in proportion to capacity. A novel PCS suitable for small capacity is proposed. This system can be performed at minimum wiring work at construction.

By means of Feed-in Tariff, the PV power generation has been developed widely. It is very important that the end user feels an economic merit which brings wide spread of PV power generation like as social phenomenon. The most important thing of proposed veranda solar is that the cost is lower than charge of electric company.

In additional important thing, the visualization tool could be mentioned, in which the generating power can be easily viewed like handy smart phone. By means of this tool, if the power can be measured as a "negawatt", economical merit can be realized and confirmed by viewing. If our visualization tool is realized with "Trade of Negawatt", which is promoted by Ministry of Economy, Trade and Industry. The veranda solar could be widely spread.

### **Acknowledgment**

This research is mostly supported by a grant of the NEDO (New Energy and Industry Technology Development Organization). We would like to express our appreciation to who it may concern about this project.

## References

- [1] Yan Hu, Keiju Matsui, Takashi Sugiyama, Kenji Ando and Isamu Yamamoto, "3kW Utility-interactive Power Conditioning System using Forward Converter", Proceedings of Static Power Converter Meeting in IEEJ, SPC-94-89, pp.49-56, (1994)
- [2] Sakae Shibasaki, Isao Takahashi, Shinzo Sakuma, Noriyasu Mimura, Yoshihiko Asano, "Small Quantity and Thin Type 200W Inverter for Photovoltaic Systems", Proceedings of National Convention in IEEJ, 739, pp.4-50-51, (1998)
- [3] Satoshi Naruse, Keiju Matsui, Shiro Hirose: 'Utility-interactive power conditioner using forward converter with double switches', Proceedings of national convention in IEEJ, 839, 1999-3
- [4] R.L.Steigerwalt, A.Ferraro, and R.G.Turnbull: 'Application of power transistors to residential and intermediate rating photovoltaic power conditioners', IEEE Trans. Ind Appl., 1983, IA-19, (2) pp. 254-260
- [5] A.Khoder, K.Al-Haddad and V.Rajagopalan: ' Innovative utility-interactive dc to ac power conditioning system'. Conference Record of 1985 IEEE IAS Annual Meeting, Toronto, Canada, 1985, pp. 1151-1155
- [6] Chihiro Okado. : 'Development of inverter for photovoltaic generation'. Proceedings of 10th Photovoltaic Generation System symposium, Tokyo, Japan, 1993, pp. 411 (in Japanese)
- [7] R.L.Steigerwalt, B.K.Bose and P.M.Szczesny: Design and construction of an advanced power conditioning subsystem for small photovoltaic applications'. Sandia Report, SAND 83-7037, 1985
- [8] Edit:Ohmsha,"Guide Book of Technical Standard Concerning Electrical Equipment", 1st edit., pp.52-63, pp.376-382, 2013
- [9] Technical Committee for Customer Equipment, edit., "Indoor Wiring Regulation - electrical code for customer equipment", Electric Association of Japan, pp.858-860, 2012-3
- [10] Keiju Matsui, Eiji Oishi, Y.Kawata, M.Yasubayashi, M.Umeno, H.Uchida, M.Hasegawa:" Simple and Concise Photovoltaic Power Generation Systems installed in Verandas of Apartment House", Journal of Japan IE, vo.94, no.6, 2015-6
- [11] Mikio Yasubayashi, Keiju Matsui, Eiji Oishi, Masayoshi Umeno, Yasutaka Kawata, Hideo Uchida:"Novel Voltage Equalizers for Secondary Batteries including EDLCs using CW Circuit ", Proceedings on Industrial Application Engineering, pp.531-535(2015-3)

[12] Hlaing Kyi Pyar Khant, Keiju Matsui, Masaru Hasegawa, Mikio Yasubayashi, Masayoshi Umeno, Eiji Oishi, “Discussion on Various Voltage Equalizers for EDLCs using CW circuit”, IPEC2014, International Power Electronics Conference, pp.183-190 (2014-5)

[13] Keiju Matsui, Eiji Oishi, Yasutaka Kawata, Mikio Yasubayashi, Masayoshi Umeno, Hideo Uchida: “Pursuit of Simple Power Conditioner for Photovoltaic Small Power Generation”, IEEE Industrial Electronics Conference, Yokohama, Proceedings of IEEE-IECON 2015, pp.556-561

**Contact email:** keiju@isc.chubu.ac.jp

***Energy and Development Discourse in Cambodia: Gaps between Energy Infrastructure for Industrial Development and the Energy Needs of People***

Maureen Boyle, Curtin University, Australia

The Asian Conference on Sustainability, Energy & the Environment 2018  
Official Conference Proceedings

**Abstract**

As the Royal Government of Cambodia attempts to lead the country from least developed to a middle income status country as classified by the United Nations, the relationship between energy and development policies and energy provision becomes a priority. Key energy and related development policy documents were collected and subjected to discourse analysis. The analysis also included transcripts of interviews with participants from the solar energy industry, development NGO's and the United Nations in Cambodia. This mixed-method investigation has identified substantial gaps between a path towards centralized energy generation with large-scale hydroelectricity and a path to decentralized energy generation including off grid, household and utility scale solar PV. With limited grid access in the rural areas of Cambodia, the policy documents recognise the role of decentralized renewable energy, particularly solar PV and small scale hydro power. They also place significant emphasis on the private sector providing energy services. However, this research has identified a lack of policy framework and incentives for providing energy for people in much of the country. It also identifies an opportunity to overcome the absence of energy network infrastructure through the adaption of supportive policy settings for transitioning Cambodia's energy sector to include a mix of decentralized renewable energy, largely comprising solar PV with grid integration where available. Additionally, more proactive energy projections and planning for energy services is required to meet the needs of industry and people.

Keywords: Cambodia; development; infrastructure; decentralized; energy policy; discourse.

**iafor**

The International Academic Forum

[www.iafor.org](http://www.iafor.org)

## Introduction

The Cambodian government's energy and related development policies are examined in this article to understand the relationship between energy policy and provision in Cambodia and discourses of the Royal Government of Cambodia, United Nations, regional organisations, non-governmental organisations (NGOs) and the solar energy industry in Cambodia. The policy analysed in this article broadly correlates to development thinking in the post 1990 era where human development, focusing on capabilities and the development of the state is central (Nederveen Pieterse, 2010, p. 10). Discourses of private investment, trade and markets also feature prominently in the policy analysed as well as themes around international cooperation.

The policy approach to development and energy services in Cambodia broadly correlates with development and ecological modernization thinking as discussed by Käkönen et al. (2014) and Moore and Schmitz (1995) with industrialization and economic growth as the foundation, however this approach is becoming increasingly obsolete and does not necessarily support the population to have access to electricity or to ensure Cambodia's future energy security.

Sachs (1993) identified the priority of sustaining 'development' that emerged from the United Nations Conference on Environment and Development (UNCED) in 1992. The 1992 declaration did not exclude discourses of climate change and renewable energy but its overall agenda prioritized economic growth and investment based on a paradigm of rapid industrialization in the name of 'sustainable development'. This is hardly surprising as highlighted by Moore and Schmitz (1995, p. 22), who discuss how the use of development as a term between 1945 and 1995 was based on an industrialization model with economic growth at its foundation. Energy services as a fundamental foundation of economic growth have largely been developed as centralized systems based on industrial and residential energy use. To consider a change in the energy trajectory (Smits, 2012) for Cambodia it is necessary to consider and recognise the competing discourses related to centralized energy generation, grid electrification, industrialization and growth that may significantly influence energy policy and provision of energy services in Cambodia and the Association of South East Asian Nations (ASEAN). This article thus seeks to begin to answer the fundamental question of what energy related policy in Cambodia is responding to with regards to energy needs, but also in relation to the influence of competing discourses, investment decisions and government priorities.

## Selection and analysis of data

Six Cambodian policy documents were selected for analysis (Table 1) in this study. Except for the Electricity Law of the Kingdom of Cambodia 2001 (hereafter electricity law) (Electricity Authority of Cambodia, 2001), all the policy documents were released between 2007 and 2017. These policy documents, including multiple drafts of the Environment and Natural Resources Code of Cambodia, were selected to capture variation and variety (Flick, 2007, pp. 27-28) in policy texts focusing on energy and development across an important period of rapid economic and energy production growth in Cambodia. In addition to the policies listed in Table 1, regulations on connecting solar PV to the national grid from the Electricity Authority of Cambodia (2018) have been released subsequently and are referred to in this article



where relevant. While discourse analytical studies are usually carried out on untranslated material (Yates et al., 2001, p. 18), the use of some translated policy documents has been an unavoidable limitation of this study. Sources of all the policy documents have been included in the list of references, and whenever a policy document has been translated from Khmer it has been indicated clearly in Table 1.

*Table 1: Cambodian energy and development policy analysed for this article*

<b>Policy or Plan</b>	<b>Government Ministry</b>	<b>Focus</b>
Electricity Law of the Kingdom of Cambodia 2001 (translated)	Electricity Authority of Cambodia	Reliable and adequate power supply at reasonable costs for consumers, principles for licensees and operations in the provision of electricity, EAC as regulator, competition and favourable conditions for investment in the power sector, and the promotion of private ownership of facilities.
National Strategic Development Plan 2014-2018 (translated)	Ministry of Planning	Comprehensive and broad focus on economic development, investment and growth, as well as governance and institutions, international cooperation and references to reducing poverty. Also contains development aspirations for Cambodia to move towards an upper middle income and developed country.
Cambodia Industrial Development Policy 2015-2025 (translated)	Ministry of Industry and Handicraft	Focus on the industrial sector. The vision of the policy is a transformation and modernisation of Cambodia's industrial structure from a labour intensive industry to a skill based industry by 2025.
Cambodia Climate Change Strategic Plan 2014-2023	Ministry of Environment (National Council for Sustainable Development)	Reducing climate change impacts to the most vulnerable, move towards a green development path and promoting awareness of and participation in climate change response.
Environment and Natural Resources Code of Cambodia (7 <sup>th</sup> , 9 <sup>th</sup> and 10 <sup>th</sup> Drafts)	Ministry of Environment	Comprehensive overview of environment and natural resource issues in Cambodia. Sustainable energy is included.
Cambodia's Intended Nationally Determined Contribution (INDC)	Royal Government of Cambodia	Cambodia's submission to the United Nations Framework Convention on Climate Change for the 21 <sup>st</sup> Conference of Parties (COP) in Paris December 2015. Details Cambodia's contribution and commitment to assist in reducing global greenhouse gas emissions.

Ten qualitative semi-structured interviews were also conducted in English with representatives from the solar energy industry, NGOs and the United Nations

Development Programme (UNDP) in Phnom Penh from 5 May 2017 to 4 June 2017. Further interviews and observations were undertaken in Phnom Penh throughout February 2018, however comprehensive data from these interviews are not included in this article, except where updates and clarifications of interpretation have been required given the fast moving context of the energy sector in Cambodia. The policy documents in Table 1 and transcriptions of the interviews from 2017 became the corpus for this study that was entered into an NVivo server for coding (Rapley & Flick, 2007, p. 130) by thematic nodes. This discourse analytical approach to energy related policy in Cambodia provided insights into the evolving narratives, changes in policy and actors shaping sociotechnical change in the country (Bulkeley, 2014, p. 961).

### **Energy situation in Cambodia and regional influence**

Electricity consumption in Cambodia has risen at an average annual growth rate of 19 per cent between 2010 and 2015 (Intelligent Energy Systems & Mekong Economics, 2016, p. 14; Ministry of Mines and Energy & Economic Research Institute for ASEAN and East Asia, 2016, p. 46). The high increase in electricity consumption in Cambodia can be related to annual Gross Domestic Product (GDP) rates of approximately 8 per cent, urban population growth and increased electrification (Intelligent Energy Systems & Mekong Economics, 2016, p. 14). Approximately 70 per cent of electricity demand is in the capital, Phnom Penh (Intelligent Energy Systems & Mekong Economics, 2016, p. 14), home to approximately 9 per cent of the national population of 16 million (United Nations Statistics Division, 2017). With rapid development in Cambodia and increasing electricity demand, there are various challenges for energy policy and provision in Cambodia. One of these challenges is meeting the actual energy needs of people in the country. In 2015, 56.1 percent of the population in Cambodia had access to electricity (World Bank, 2016), however the rate of electrification is increasing rapidly in Cambodia. Figures from an energy access workshop in Phnom Penh in November 2017 state that 71.5 percent of households in Cambodia are now grid connected based on a multi-tier framework survey conducted in 2017 (World Bank Group, 2017). It is not clear however if energy related policy in Cambodia is responding to the energy needs of the population.

Shove and Walker (2014, p. 42) have challenged energy policy to focus less on the technologies, infrastructures and politics of power and more on the fundamental question of what energy enables us to do in daily practice. This question is significant for Cambodia if we consider the lack of electricity access for a significant percentage of the population and increasing energy demand in the region, however Smits (2012, pp. 188-189), argues that this focus is predominately based on western practices of energy use. Kivimaa and Kern (2016, pp. 208, 215), also discuss the most beneficial policy support for sustainability transitions, which includes support for niche innovations such as research and development funding, as well as a destruction of incumbent regimes through the withdrawal of supportive policies including taxes and regulations. Yet, Cambodia's current energy policy settings have not provided a supportive environment for effectively leading a transition in the energy sector and in some cases are further entrenching the incumbent regime by hindering the export of household solar PV generation to the grid (Electricity Authority of Cambodia, 2018).

Affordability of electricity is another issue and a key focus of the Cambodian Government with the country suffering from some of the highest electricity prices in the world, largely due to electricity imports (Urban et al., 2017). Individual households are also required to pay the grid connection costs as grid infrastructure becomes available. Figures on connection costs for households vary from USD \$80 to \$300. Historically, Cambodia was reliant on imported oil for electricity generation with prices fluctuating with world oil prices. From 2012 onwards with increased imported electricity from neighbouring countries (mainly Vietnam and Thailand) and increased generation from coal and hydroelectricity, electricity tariffs have been reduced. This is projected to continue to decline, however prices remain high in comparison to the region (Derbyshire, 2015, p. 5).

Within ASEAN, the rate of electricity consumption grew 5.1 per cent per year on average between 2010 and 2015, compared to 19 per cent per year in Cambodia over the same period (ASEAN Centre for Energy, 2015a, p. 32). Projections for the growth of electricity in ASEAN remains around 5-7 per cent per year from 2016 to 2020 (ASEAN Centre for Energy, 2015b, p. 17; Chang & Li, 2013, p. 153). Increasing energy needs within ASEAN has created the impetus for centralized and interconnected power grids across the region. Vietnam, Thailand, Malaysia and Singapore are expected to be the beneficiaries of imported electricity from Myanmar, Laos and Cambodia (International Energy Agency, 2015, p. 109). The transmission of electricity through borders is planned across an integrated power network throughout Southeast Asia, named the ASEAN Power Grid. The vision for this grid was determined at the second ASEAN Informal Summit in 1997 by heads of state as part of the ASEAN Vision 2020 (Chang & Li, 2013, p. 153). Cambodia was not a member of ASEAN at this time, becoming the last member to join in 1999 (Narine, 2006).

Although the full vision of the ASEAN Power Grid has not yet been implemented, transmission and trade of electricity already occurs between Cambodia, Vietnam, Thailand and Laos with Cambodia importing 56 per cent of electricity demand in 2013. However, 2014 and 2015 shows lower imports than the peak of imported generation in 2013 at 2282 GWh (Ministry of Mines and Energy & Economic Research Institute for ASEAN and East Asia, 2016, p. 12). Imports of electricity from Laos to Cambodia have been reduced by additional hydroelectric generation in Cambodia (Intelligent Energy Systems & Mekong Economics, 2016, p. 42).

Cambodia is also increasingly influenced by foreign donors and investors from China, India, Korea and Thailand (Sato et al., 2011, p. 2091). Cambodia, as part of the Lower Mekong Basin is affected by hydropower projects along the various tributaries of the Mekong River. These hydropower projects are supported by international finance and the Asian Development Bank to contribute to plans for the Greater Mekong Subregion, that includes energy trade and cooperation across borders (Yong & Grundy-Warr, 2012, pp. 1037-1038). China is also investing in hydropower and infrastructure projects in Cambodia, including roads and transmission lines (Sato et al., 2011). According to Heng (2015), there are 17 power generation projects planned in Cambodia for completion by 2020, eight of which are hydropower projects and several are coal fired power plants. Transmission lines and substations are also being constructed as part of these developments. Heng (2015, p. 415) notes an investment of USD \$1.8 billion from China to provide hydroelectric dams with a total capacity of 915MW.

## Energy related discourse

The official policy of the Royal Government of Cambodia consists of two electrification targets based on two different indicators for energy access. The first target, based on the village level is that all villages will have access to electricity supplied by the grid and other sources by 2020 (Electricite du Cambodge, 2015; Royal Government of Cambodia, 2014). The second target is that 70 per cent of households will have access to grid quality electricity by 2030 (Electricite du Cambodge, 2015; Sarraf et al., 2013). The distinction between these two targets is important to clarify. In interviews with NGOs and the solar industry in Cambodia, it was pointed out that what is happening in regards to the first target of all villages having access to electricity supplied by the grid by 2020, is that in a particular village, one house may be connected to the grid, leaving the remaining houses in that village without access to grid electricity. Observations from fieldwork in Cambodia and discussions with the solar energy industry in February 2018, indicate that distribution lines are going through villages, however many houses remain unconnected.

The actual costs for a household to connect to the grid is prohibitive for many people in Cambodia and this cost falls on the individual household to pay for this connection. Discussions with the solar energy industry in Cambodia indicate that many people want access to grid electricity. The Royal Government of Cambodia does have an incentive program in place to assist people to pay for this connection cost, called Power to the Poor. This program provides interest free loans for connection fees and installation of wires from the connection point to the house (Electricite du Cambodge, 2015). It is unclear what the uptake of this program is and interviews with the solar energy industry in Cambodia suggest this is minimal. It was suggested that many people in areas that have the connection point of one house connected, will still choose solar PV and a lead acid battery for their energy needs due to the prohibitive cost and perceptions of reliability for grid electricity in rural areas. Household energy use in rural areas is largely for lighting, TV, fan, sound system and charging of phones. For cooking there is still significant reliance on wood fuel and charcoal, with more than 80 per cent of the population still reliant on wood fuel (Royal Government of Cambodia, 2013).

Reference to regional energy cooperation and the ASEAN Power Grid is mentioned in the National Strategic Development Plan 2014-2018 and the Cambodia Industrial Development Policy 2015-2025. The concept of integrated energy networks and energy trading between nations in ASEAN and the broader region is not included in any other policy documents analysed. Discussion of the ASEAN Power Grid is noted in reference to Cambodia having participated in the implementation of the ASEAN Power Grid as well as noting Cambodia's participation in the Greater Mekong Sub-region Power Trade Plan (Royal Government of Cambodia, 2014, p. 47). With increasing distribution infrastructure being developed in Cambodia, there is the real possibility of increased energy cooperation between nations within ASEAN and China, however the significant transmission losses throughout the national grid in Cambodia makes the efficiency of a fully integrated network questionable (World Bank, 2014). Energy and development policy in Cambodia does not appear to be focused or strategically planned for energy trading between nations of ASEAN and if the simulation discussed by Ahmed et al. (2017) is an accurate depiction of the future of energy cooperation in the region, substantially more generation capacity would be

required from Cambodia.

Article 16 of the 7<sup>th</sup> draft of the environmental code, discussed the promotion of mini and micro grid supply, in areas where the national grid exists or where the grid is yet to arrive (Vishnu Law Group, 2016). References to the grid have been removed from the 9<sup>th</sup> and 10<sup>th</sup> drafts as well as reference to the responsible entity, Electricite Du Cambodge (EDC). The same article 261 in the 10<sup>th</sup> draft is devoid of any responsible institution and instead refers to competent ministries or institutions that support the provision of mini and micro grids and does not specify any particular generation source such as solar or diesel. This particular article also notes the entering into agreements with electricity providers to sell electricity, however again the electricity providers are not identified (Vishnu Law Group, 2018, pp. 76-77). There is a requirement under the electricity law to have a license as an Independent Power Producer from the Electricity Authority of Cambodia (EAC) to operate a mini or micro grid. As discussed with the solar energy industry in Cambodia, these licenses are traditionally difficult for the solar energy industry to get, as a proven record is required. One Rural Electricity Enterprise (REE) in Cambodia was able to set up a solar mini grid system through the use of a sub-license, however over the long term it was not financially viable for the REE due to a lack of enforcement for payments.

When it comes to energy supply, a priority of the Royal Government of Cambodia is the supply of reliable electricity to major production zones and to areas that have factories to presumably assist in meeting the goal of industrial development in the country (Royal Government of Cambodia, 2015b). The language used in the recent Scaling up Renewable Energy Program (SREP) Investment Plan for Cambodia also suggests that a great deal of new renewable energy projects will be located in industrial areas with the change in the revised investment plan. The change is due to lessons learned from the competitive tender process for the 10MW Bavet solar project as well as work done on grid integration for utility scale solar, which concluded that it is possible for Cambodia to have up to 150MW of utility scale solar on the grid (Climate Investment Funds, 2017). Focusing efforts on utility scale solar will meet the goals of prioritising energy supply to production zones, however it may not resolve meeting the energy needs of people in Cambodia. The lack of public sector financing and strategic direction in energy policy throughout many of the documents analysed and discussed in this paper may have longer term detrimental effects on achieving poverty reduction and electricity access for the population (Aalto, 2016, p. 95; Falkner, 2014, p. 193).

Several of the policy documents also refer to support and promotion of decentralized energy in the form of solar, biogas, biomass, solar home systems, household rooftop solar and micro and mini hydropower as well as the integration of renewables into the grid, particularly solar (Royal Government of Cambodia, 2013, 2015a; Vishnu Law Group, 2016). Article 260 of the 10<sup>th</sup> draft of the environmental code specifically promotes the supply of decentralized electricity, noting that electricity users shall have the right to choose to use the electricity from any source of electricity generation (Vishnu Law Group, 2018, p. 76). This suggests that there is a recognition from the Royal Government of Cambodia that not all households will have access to grid electricity, and that decentralized sources of electricity have a place in Cambodia now and in the future. However, when it comes to connecting these sources of decentralized energy to the national grid, particularly in the case of household solar

PV, the EAC in their recent regulations on connecting solar PV to the national grid, prevent any export of this electricity to occur (Electricity Authority of Cambodia, 2018). Thus decentralized sources of energy that are for own use and located off the national grid can be promoted, however there are barriers in place for household decentralized solar PV to connect and export electricity to the grid. Within the EAC regulations, allowances are made for medium to high voltage customers to install solar PV as long as certain conditions are met which include inverters programmed so that consumption of the electricity from the solar PV occurs, with no export. However there may be exceptions where permission is provided for the export of electricity, if an agreement is in place with EDC (Electricity Authority of Cambodia, 2018, pp. 5-6).

The discussion with the solar energy industry in Cambodia reveals that there is a recognition that having some regulations and grid connection codes would be useful as a longer term strategy and particularly that net metering should be a focus in order to deduct electricity generated and exported into the grid from consumer's electricity bill. The 7<sup>th</sup>, 9<sup>th</sup> and 10<sup>th</sup> drafts of the environmental code also includes an article on net metering, noting that this legal instrument shall be established by the responsible legal entity. In the 7<sup>th</sup> version of the code, this responsible legal entity was identified as EDC, however this reference has been removed in later versions (Vishnu Law Group, 2016, 2017, 2018). Despite the promotion of decentralized energy production, there is still a desire for grid expansion evident throughout the policy documents and the grid infrastructure is indeed expanding in Cambodia.

Issues of capacity and technical knowledge and skills were also discussed with the solar energy industry in Cambodia and this was an area that the industry and NGOs in the solar energy sector were actively involved with by providing training for local electricians and installers. According to the industry members, the capacity and technical skills for solar PV installations exist in the country, however when questioned on whether the technical skills in designing off grid renewable energy systems were available it emerged that these skills were limited in Cambodia. The solar energy industry in Cambodia however are proactive in developing training for people in the country. Some institutions and NGOs in Cambodia also offer courses and training, such as the Institute of Technology which offers a free 100 hour course for solar engineering. The Department of Physics at the Royal University of Phnom Penh also has some course modules on renewable energy systems and electricity generation that was developed with assistance from Engineers without Borders (Royal University of Phnom Penh, 2016).

## **Conclusion**

Development and energy related policy and the recent SREP investment plan for Cambodia has a significant reliance on private investment for energy infrastructure, including generation, transmission and distribution infrastructure. With a significant proportion of the country still not electrified, the focus on private investment in energy infrastructure is likely to intensify. The policy also has a focus on energy infrastructure for industrial development and this is apparent where new energy solar PV generation is located, such as the 10MW solar PV plant in the Special Economic Zone of Bavet and the revised SREP investment plan which prioritise a 100MW project and utility scale parks. Where this leaves the population without energy access

is still unclear, particularly with the relatively high costs for grid connection that householders are required to pay. In terms of rural electrification, the Royal Government of Cambodia appears to be *laissez-faire*, apart from ensuring regulations and licenses for Independent Power Producers, grid connection fees and ensuring that the generation of solar PV on the grid is kept to a minimum. Anything outside of these parameters is open to private actors and local communities to either informally connect to the few houses in the village that may have grid access or source their own power from Independent Power Producers or solar PV and battery systems. The approach is one of recognition of the need for decentralized energy, however there is hesitancy in the policy documents on the role of decentralized renewable energy in Cambodia and there is no clear strategy to ensure that people have access to affordable electricity.

Electrification is occurring rapidly in Cambodia, however it is not clear where electrification of the country is leading to with regards to electricity access as the focus appears to be on industrial development. In addition, the policy documents do not have a strong focus on an integrated regional network, such as the ASEAN Power Grid and the lack of strategy in increasing generation capacity and the ability of the national grid to integrate renewable energy generation such as solar PV suggests a lack of vision for the energy sector in Cambodia. However Cambodia is interesting as there is recognition by the government of the role of decentralized energy and on the ground there is a great deal of innovation in the energy sector by various private actors with a focus on energy access and also to some extent training and capacity development. This innovation and enthusiasm for developing the solar PV sector more on the ground is not being supported and in some cases is being actively stifled by recent policy developments in Cambodia. If Cambodia is serious about meeting international policy commitments, such as the Intended Nationally Determined Contribution submitted to the Conference of Parties in Paris, which states the intention to connect decentralized renewable energy to the grid, it may be strategic for energy and development policy in Cambodia to include a mix of supportive policy mechanisms to transition the energy sector toward a more sustainable path.

As discussed by Kivimaa and Kern (2016) supportive policy can be multifaceted to include niche support to increase knowledge such as funding for research and development in the energy sector as well as policies and regulations that reduce risk and uncertainty for investors and entrepreneurs in decentralized renewable energy projects. As there is a focus in the policy documents on the development of human capacity, this support can be better targeted into educational institutions in Cambodia as well as working strategically with the wealth of knowledge that is available in Cambodia through the solar energy industry and other entrepreneurs already working on the ground. It may also be prudent to strategically look at the gaps in energy services, as well as the energy needs in rural areas to assist communities to have energy services that meet their needs. In addition, having supportive regulations, grid connection codes and net metering, could assist Cambodia in better projecting and planning for energy generation in the future as well as being able to manage and better integrate renewable energy generation on the national grid. Private investment is unlikely to meet the needs of local communities and affordability of these energy services may also be an issue.

The development of capacity within the energy sector is an enormous opportunity for

Cambodia and some NGO's have started this process as discussed such as the development of a renewable energy curriculum at the Royal University of Phnom Penh. The solar energy industry in Cambodia are also reasonably proactive in developing capacity within Cambodia in terms of training for installations of off-grid solar PV systems, which could be more effectively utilized, supported and scaled up by the Royal Government of Cambodia through dialogue with the solar energy industry in Cambodia. As poverty reduction is also a significant focus of the Royal Government of Cambodia, it may be prudent to note the overreliance on private investment in energy infrastructure and adopt a broader development approach that includes longer term benefits, employment, training, and education opportunities for Cambodians. Providing a clear policy framework for the energy sector in Cambodia informed by energy needs of people, industry and involving relevant stakeholders would be of strategic value to the Cambodian Government. If there is to be a mix of centralized and decentralized renewable energy, particularly solar PV, it would be helpful for the Cambodian Government policy to provide this direction and support in meeting the energy needs of people and industry.

### **Acknowledgements**

Acknowledgements and thanks to Dr Thor Kerr and Professor Greg Morrison who assisted in providing constructive feedback, comments and edits on previous drafts of this paper. I would also like to thank Dr Barry Tapp for his continual mentorship, advice and wisdom.



## References

Aalto, P. (2016). The new International Energy Charter: Instrumental or incremental progress in governance? *Energy Research & Social Science*, 11, 92-96. doi:10.1016/j.erss.2015.09.006

Ahmed, T., Mekhilef, S., Shah, R., & Mithulananthan, N. (2017). Investigation into transmission options for cross-border power trading in ASEAN power grid. *Energy Policy*, 108, 91-101. doi:10.1016/j.enpol.2017.05.020

ASEAN Centre for Energy. (2015a). The 4th ASEAN Energy Outlook 2013-2035. Retrieved from <http://www.aseanenergy.org/resources/publications/the-4th-asean-energy-outlook/>

ASEAN Centre for Energy. (2015b). ASEAN Plan of Action for Energy Cooperation (APAEC) 2016-2025. Retrieved from <http://www.aseanenergy.org/resources/publications/asean-plan-of-action-for-energy-cooperation-apaec-2016-2025/>

Bulkeley, H. (2014). Revisiting ... Discourse Coalitions and the Australian Climate Change Policy Network. *Environment and Planning C: Government and Policy*, 32(6), 957-962. doi:10.1068/c3206r

Chang, Y., & Li, Y. (2013). Power generation and cross-border grid planning for the integrated ASEAN electricity market: A dynamic linear programming model. *Energy Strategy Reviews*, 2(2), 153-160. doi:10.1016/j.esr.2012.12.004

Climate Investment Funds. (2017). Scaling up Renewable Energy Program (SREP): Revised Investment Plan for Cambodia. Retrieved from <https://www.climateinvestmentfunds.org/country/cambodia/cambodia-srep-programming>

Derbyshire, W. (2015). Cambodia – In Depth Study on Electricity Cost and Supplies. Retrieved from <http://www.seac-cambodia.org/wp-content/uploads/2016/06/Cambodia-in-depth-study-on-electricity-cost-and-supplies-Final-Report.pdf>

Electricite du Cambodge. (2015). *Program for the Development of Rural Electrification*. Phnom Penh Retrieved from [http://ref.gov.kh/page/admin/public/filedownload/pro\\_brochure%20ref\\_eg%202015-new.pdf](http://ref.gov.kh/page/admin/public/filedownload/pro_brochure%20ref_eg%202015-new.pdf).

Electricity Authority of Cambodia. (2001). *Electricity Law of the Kingdom of Cambodia*. (ROYAL DECREE No. NS/RKM/0201/03). Retrieved from <http://eac.gov.kh/wp-content/uploads/2014/05/2nd-Amendmend-of-Electricity-Law.pdf>.

Electricity Authority of Cambodia. (2018). *Regulations: On General Conditions for connecting Solar PV Generation sources to the Electricity Supply System of National Grid or to the Electrical System of a Consumer connected to the Electricity Supply System of National Grid*. Phnom Penh Retrieved from <https://eac.gov.kh/site/regulation?lang=en>.

Falkner, R. (2014). Global environmental politics and energy: Mapping the research agenda. *Energy Research & Social Science, 1*, 188-197.  
doi:10.1016/j.erss.2014.03.008

Flick, U. (2007). *Designing qualitative research*. London: SAGE.

Heng, P. (2015). China's role in the Cambodian energy sector: Catalyst or antagonist for development? *South East Asia Research, 23*(3), 405-422.  
doi:10.5367/sear.2015.0272

Intelligent Energy Systems, & Mekong Economics. (2016). Alternatives for Power Generation in the Greater Mekong Subregion. Power Sector Vision for the Kingdom of Cambodia. Retrieved from [http://wwf.panda.org/what\\_we\\_do/where\\_we\\_work/greatermekong/our\\_solutions/2050powersectorvision/](http://wwf.panda.org/what_we_do/where_we_work/greatermekong/our_solutions/2050powersectorvision/)

International Energy Agency. (2015). South East Asia Energy Outlook 2015. Retrieved from <http://www.iea.org/publications/freepublications/publication/world-energy-outlook-special-report-on-southeast-asia-2015.html>

Käkönen, M., Lebel, L., Karhunmaa, K., Dany, V., & Try, T. (2014). Rendering Climate Change Governable in the Least-Developed Countries: Policy Narratives and Expert Technologies in Cambodia. *Forum for Development Studies, 41*(3), 351-376.  
doi:10.1080/08039410.2014.962599

Kivimaa, P., & Kern, F. (2016). Creative destruction or mere niche support? Innovation policy mixes for sustainability transitions. *Research Policy, 45*(1), 205-217. doi:10.1016/j.respol.2015.09.008

Ministry of Mines and Energy, & Economic Research Institute for ASEAN and East Asia. (2016). Cambodia National Energy Statistics 2016. Retrieved from [http://www.eria.org/RPR\\_FY2015\\_08.pdf](http://www.eria.org/RPR_FY2015_08.pdf)

Moore, D. B., & Schmitz, G. (1995). *Debating development discourse: institutional and popular perspectives*. New York: St. Martin's Press.

Narine, S. (2006). The English School and ASEAN. *The Pacific Review, 19*(2), 199-218. doi:10.1080/09512740500473247

Nederveen Pieterse, J. (2010). *Development theory* (2nd ed.). London: SAGE.

Rapley, T., & Flick, U. (2007). *Doing conversation, discourse and document analysis*. London: Sage Publications.

Royal Government of Cambodia. (2013). *Cambodia Climate Change Strategic Plan 2014-2023*. Phnom Penh, Cambodia Retrieved from [http://www.kh.undp.org/content/cambodia/en/home/library/environment\\_energy/cambodia-climate-change-strategic-plan-2014--2023.html](http://www.kh.undp.org/content/cambodia/en/home/library/environment_energy/cambodia-climate-change-strategic-plan-2014--2023.html).

Royal Government of Cambodia. (2014). *National Strategic Development Plan 2014-2018*. Phnom Penh: Royal Government of Cambodia Retrieved from [http://cdc-crdb.gov.kh/cdc/documents/NSDP\\_2014-2018.pdf](http://cdc-crdb.gov.kh/cdc/documents/NSDP_2014-2018.pdf).

Royal Government of Cambodia. (2015a). *Cambodia's Intended Nationally Determined Contribution*. UNFCCC Retrieved from <http://www4.unfccc.int/Submissions/INDC/Published%20Documents/Cambodia/1/Cambodia%27s%20INDC%20to%20the%20UNFCCC.pdf>.

Royal Government of Cambodia. (2015b). *Cambodia Industrial Development Policy 2015-2025*. Retrieved from [http://www.mih.gov.kh/File/UploadedFiles/12\\_9\\_2016\\_4\\_29\\_43.pdf](http://www.mih.gov.kh/File/UploadedFiles/12_9_2016_4_29_43.pdf).

Royal University of Phnom Penh. (2016). Department of Physics - Course Description. Retrieved from <http://www.rupp.edu.kh/fs/physics/?page=Course%20Description>

Sachs, W. (1993). *Global Ecology: A New Arena of Political Conflict*. London: Zed Books.

Sarraf, M., Rismanchi, B., Saidur, R., Ping, H. W., & Rahim, N. A. (2013). Renewable energy policies for sustainable development in Cambodia. *Renewable and Sustainable Energy Reviews*, 22, 223-229. doi:10.1016/j.rser.2013.02.010

Sato, J., Shiga, H., Kobayashi, T., & Kondoh, H. (2011). "Emerging Donors" from a Recipient Perspective: An Institutional Analysis of Foreign Aid in Cambodia. *World Development*, 39(12), 2091-2104. doi:10.1016/j.worlddev.2011.04.014

Shove, E., & Walker, G. (2014). What Is Energy For? Social Practice and Energy Demand. *Theory, Culture & Society*, 31(5), 41-58. doi:10.1177/0263276414536746

Smits, M. (2012). The Benefits and Complexities of Distributed Generation: Two Energy Trajectories in Laos and Thailand. *Forum for Development Studies*, 39(2), 185-208. doi:10.1080/08039410.2012.666216

United Nations Statistics Division. (2017). UN Data - Cambodia. Retrieved from <http://data.un.org/CountryProfile.aspx?crName=cambodia>

Urban, F., Siciliano, G., & Nordensvard, J. (2017). China's dam-builders: their role in transboundary river management in South-East Asia. *International Journal of Water Resources Development*, 1-24. doi:10.1080/07900627.2017.1329138

Vishnu Law Group. (2016). Environment and Natural Resources Code of Cambodia (7th Draft) *7th Draft*. Retrieved from <http://matthewbaird.com.au/wp-content/uploads/2017/01/ENR-Code-Draft-7-Final-31-DEC-16.pdf>

Vishnu Law Group. (2017). Environment and Natural Resources Code of Cambodia (9th Draft) *9th Draft*. Retrieved from <http://matthewbaird.com.au/wp-content/uploads/2017/07/ENR-Code-Draft-9.1-in-English-25.07.2017.pdf>  
<http://matthewbaird.com.au/category/countries/asean/cambodia>

Vishnu Law Group. (2018). *Environment and Natural Resources Code of Cambodia (10th Draft)*. Retrieved from <http://www.vishnulawgroup.com/index.php/publications/74-2018-02-22-09-24-41>.

World Bank. (2014). Electric power transmission and distribution losses (% of output). from OECD/IEA <https://data.worldbank.org/indicator/EG.ELC.LOSS.ZS>

World Bank. (2016). Access to Electricity (% of population). [http://data.worldbank.org/indicator/EG.ELC.ACCS.ZS?name\\_desc=false](http://data.worldbank.org/indicator/EG.ELC.ACCS.ZS?name_desc=false)

World Bank Group. (2017). *Cambodia: Results based on Energy Access Diagnostic Multi-Tier Framework*. Presentation. Ministry of Economy and Finance, Ministry of Mines and Energy. World Bank Group, Energy Sector Management Assistance Program. Phnom Penh.

Yates, S., Taylor, S., & Wetherell, M. (2001). *Discourse as data: a guide for analysis*: SAGE Publications Ltd.

Yong, M. L., & Grundy-Warr, C. (2012). Tangled Nets of Discourse and Turbines of Development: Lower Mekong mainstream dam debates. *Third World Quarterly*, 33(6), 1037-1058. doi:10.1080/01436597.2012.681501

## ***Cultural Sustainability of India: A Survival Story***

Rupa Singh, Anant National University, India

The Asian Conference on Sustainability, Energy & the Environment 2018  
Official Conference Proceedings

### **Abstract**

This paper explores the Cultural Sustainability of India by protecting, preserving and conserving the transparent, ethical and responsible model of ancient India with reference to Vedic literature, Upanishad and Kautilya's Arthashastra. Stories of sustainability and survival deal with land, justice, foreign policy, war and environment through the ages. The Constitution of India upholds the cultural identity of India intact and is largely responsible for cultural and social sustainability of India at present. Besides, India must not – in the rat race for surviving and thriving after the “Brundtland Report” of 1987 – forget the ancient knowledge of sustainability, values and principles, the middle path of Lord Buddha and treatise like Chanakya Neeti. Hinduism, a way of life also acts as the pillar for social, economic and environmental development. The paper emphasises on events, policies and pacts where it went wrong in history and the cultural sustainability of India that acted for its survival. The paper through different examples concludes that inclusive and tolerant culture of India revamp the sustainability in general and cultural sustainability in particular, helping India survive and thrive in the world carving a niche for her.

Keywords: Sustainability, The Constitution of India, Brundtland Report, Hinduism, tolerant culture.

**iafor**

The International Academic Forum  
[www.iafor.org](http://www.iafor.org)

## Introduction

India, a land of diversity occupies 3.2 million sq.km of land area i.e. 2.4% of the world's land area and is seventh largest in size but supports 1.3 billion i.e. 17% of the world's population in 2018. She is 2<sup>nd</sup> most populous country in the world after China and is likely to be the most populous by 2024. India is diverse by the ways she thinks of herself, and various identities she has accumulated over time due to her beliefs, values, actions and aspirations. She is multilingual and has 22 Scheduled languages recognized officially. India is famous for its tradition on the world's platform as Mark Twain rightly puts it in his words, "India is the cradle of human race also the birth-place of human speech. The mother of history, the grandmother of legend also the great grandmother of tradition. Our most valuable and most constructive materials in the history of man are treasured up in India only". Resultant of action of human race is collaboration of people, environment and habits of people engaged.

From time immemorial, Dharma (moral behavior), artha (wealth), kama (worldly pleasures) are highly recommended to be practiced, is practiced and studied for obtaining moksha (salvation). India with her quest to attain salvation stands at 131<sup>th</sup> position in Human Development Index (HDI) in year 2017 ranked by United Nations Development Programme amongst 188 countries, with value of 0.64 falling in medium category. HDI is measured by taking into consideration three basic human development indicators namely life expectancy at birth, education and per capita income. If we look at the second factor for the resultant of action of human race, environment; India hasn't performed well on the Global Platform. She ranks 177<sup>th</sup> out of 180 countries surveyed by World Economic Forum on Environmental Performance Index (EPI) in 2017. EPI is measured on 24 performance indicators across 10 issues covering environment, health and ecosystem. India is at the bottom five countries and is not even slightly promising and inviting for food of thought about Sustainability. The third factor, habits of people or way of life appears optimistic with reference to HDI and EPI. India stands first in the World Economic Forum's Greendex among 18 countries surveyed and study compiled annually by National Geographic and GlobalScan Consumer index in 2017, Greendex being an international report on sustainable living. The score is based on habits of participants in area of energy conservation, consumption pattern in food, transportation, purchase habits, and attitude in other aspects as well. Countries included in survey were mostly developed countries. One may argue that India is home to the largest number of people below international poverty line hence sustainable attitude comes in habit out of necessity and not willingness. However, one must not forget that India is the third largest economy in the world as per World Bank. Less wasteful attitude is embedded in the philosophy of Indians.

Symbiosis among people, environment and people's reaction for environment is extremely important to bring all the factors of development of human race at the zenith of progress and survival, leading civilisation to thrive. Methodologies adopted are qualitative research and conceptual discussion.

## Sustainability and Cultural Sustainability

India aspires to be on path of Sustainability and had voluntarily presented her National Review on Implementation of Sustainable Development Goals(SDGs) in July 2017 to UN's High Level Political Forum. SDGs aims to make this world a better

place by enacting on its seventeen set goals by 2030, which is popularly referred as Agenda 2030. The slogan of “Sabka Saath, Sabka Vikas” by Honourable Prime Minister of India, Mr. Narendra Modi is in line with the universal principle of Agenda 2030 to ‘Leave No one Behind’.

Goal no.11 of SDGs is about sustainable cities and communities. Presently, India and the world alike face problems of urban sprawl, injustice, environmental degradation, hunger, war etc. Four pillars of Sustainable Community Development are economic prosperity, cultural vitality, social equity and environmental sustainability representing financial stability and higher standard of living; creative diversity and innovation; justice and welfare; and ecological balance respectively. Development is recognised best by the first pillar i.e. economic prosperity or growth leading to enlargement of choices and ability to acquire different types of insurances. The word sustainable development being debatable gave way to sustainability and even three spheres of sustainability- environment, economic, and social were declared to be part of culture; culture being an overarching envelope for three spheres of sustainability. Cultural indicators are value (Content), processes and medium (Practice) and manifestations (Results). Culture had been defined as identities, values, way of life, medium and message etc. by different authors. Judy Spokes, Executive Officer of the Cultural Development Network says, “Culture is both ‘overarching and underpinning’. Hence, Cultural Sustainability is crucial for surviving and thriving of any human race.

Cultural Sustainability is root cause of civilisation. If civilisation is the flesh, culture is bone to flesh. Failure of culture automatically fails civilisation. “In French tradition, civilisation was conceived of as a complex whole encompassing political, economic, religious, technical, moral and social facts. German philosophers on culture separate intellectual, artistic and religious facts from the political, economic and social phenomenon”. Indians would take culture for bone of civilisation and would separate or amalgamate various factors accordingly. John Howard says, “Nothing is more important to a country than the way it thinks of itself and national character is an important factor in achieving prosperity”. Culture gives character to any country.

### **Vedic Philosophy of India**

Indian philosophy presently is constant reactions between orthodox Hindu Philosophy, non-orthodox Hindu Philosophy, other religious philosophy, literatures like Panchatantra, Kautilya’s Arthashastra, Chankya Neeti and modern literature on various subjects including the Constitution of India. Hindu Philosophy comprises of six schools of Orthodox (astik) Hindu Philosophy and three non-orthodox (nastika) Hindu Philosophy. Orthodox school of philosophy includes Yoga, the school of Patanjali; Nyaya, the school of logic; Vaisheshika, the atomist school; Purva Mimamsa, the tradition of Vedic exegesis whereas non-orthodox school of thoughts include Buddhism, Jainism and Carvaka. Former accepts the testimony of Vedas whereas later doesn’t.

Vedic Philosophy believes in reality of cosmic unity, eternity of human spirit, reverence for the past and principles of ‘Sarva Dharma Sambhao’ and metaphysics i.e. Nature of reality. Vedas are collections of thoughts. Vedic thoughts differ in early Vedic period and later Vedic period. Isopanishad says, “This universe is creation of the Supreme Power meant for all the benefit of all his creation. Each individual life-form

must, therefore learn to enjoy its benefits by forming a part of the system in close relation with other species. Let not anyone, species encroach upon the other's right."

Buddhism and Jainism became popular among lower strata of society who were victims of caste system made by brahminical society. Lord Buddha preached about the eight-fold middle path which were Right View, Right Thought, Right Speech, Right Action, Right Livelihood, Right Effort, Right Mindfulness and Right Concentration. He didn't advocate the extremities of later Vedic period. Besides, Lord Buddha accepted that it's impossible to get rid of 'moh' which is advocated by Bhagwat Geeta. Thus, he asked commoners to choose middle path for salvation. Buddhist Philosophy was easier for common man to relate to. Jainism on other hand advocated 'Ahimsa', i.e. Non-violence. 'Meghadutta' by Kalidasa, one of the greatest poet of Sanskrit whose writings were inspired from Vedas, and Puranas; talks about animal sacrifice. Jainism is strictly against butchering animals in sacrifice and is credited by many eminent personalities like Vivekananda and Bal Gangadhar Tilak in influencing thoughts against animal's sacrifice. Indeed, both schools of thought have influenced the other immensely.

Besides, religious philosophy; Kautilya's Arthashastra deals with the well-being of individuals and nation with respect to wealth, law and justice, foreign policy, defence and war. Kautilya says in concluding section of his book: 'The source of the livelihood of men is wealth'. Arthashastra means 'Science of Economics'. According to Kautilya, 'The State or Government has a crucial role to play in maintaining the material well-being of nation and its people.'. Besides, the State is also responsible for upholding law and justice in all walks of lives and amongst various groups of society. Hence, 'dandaniti' or enforcement of laws is an integral part of Arthashastra. Arthashastra is contemporary and relevant even today in the sense that it's economic system and allied sciences was designed for the state approximately as large in size as present day India. He says, 'The wealth of the state was the totality of the surplus stored in king's treasury, the commodity warehouse, the granary, the store for forest produce and the ordnance depots (2.5.1). Of these, the treasury was the most important; the king is advised to devote his best attention to it, because all the activities of the state depended on it (2.8.1, 2). He also emphasizes, 'The value of land is what man makes of it' (7.11.9). Kautilya establishes the relation of land use, quality of land as per rainfall, its terrain, physiology etc. and types of settlement coming up. In other words, he talked about land management. If one analyses the foreign policies by Kautilya; he finds that Kautilya propounded the theory of immediate neighbouring state being the enemy; and a neighbour's neighbour separated from oneself by the intervening enemy to be a friend. He advocated states to take into consideration both short-term and long-term advantages; and adopt policies which would let one to survive show his valour for another day instead of sacrificing oneself foolishly. He says, "Any human action which increases one's welfare is a good policy; otherwise it is a bad policy' (6.2.6-12). The six methods of foreign policies are 'samdhi', making peace; 'Vigraha', hostilities; 'Asana', staying quietly and 'Yana', preparing for war; 'samsraya', seeking protection and 'Dvaidhibhava', is the policy of making peace with a neighbouring king and seek his help. He also made detailed manual on law and justice dealing validity of contracts, sale, purchase, gifts, women, and impartial punishment. "It's the power of punishment alone, when exercised impartially in proportion to the guilt, and irrespective of whether the person punished is the King's son or an enemy, that protects this world and the next." (Kautilya, p.77). The essence and importance of



Kautilya's Arthashastra can even be compared to the Constitution of independent India presently.

The Constitution of India is core structure or basic structure of Soul of India. Though many features of Indian Constitution are borrowed from Constitutions of other countries, it is special and distinguished in its own ways. Keeping in mind the diversity of India, the founding Fathers didn't want to miss on details and hence it's the lengthiest written Constitution. Words, 'Sovereign, Socialist, Secular, Democratic, Republic, Justice, Liberty, Equality, and Fraternity enshrined in the Preamble of the Constitution of India; describe the true spirit of the country and is like 'identity card of the Constitution'. Besides, there are other gems of literature like 'Vidur Neeti', book of Wisdom; and fables like Panchatantra written by Pandit Vishu Sharma. Panchatantra meaning 'five books' is the oldest collection of Fables is book of Nitishastra or wise conduct having moral or philosophical theme and had stood the test of time of technology, modern madness and atomic fear. All the above treatises and many more have shaped the country in its present form.

## **Culture and Way of life in Ancient, Medieval and present India**

### ***Social and Educational System***

Culture and way of life of people in ancient, medieval and present India is largely the work of thoughts of individuals and nation as a whole and Vedic philosophy and timeless treatises. India, socially is a nation of joint family system. C. Hui and H. Triandis defined collectivism, which is the opposite of individualism as, "a sense of harmony, interdependence and concern for others". In case of disagreements, final decision is taken by head of the family. Vedic philosophy demands elders and head of the family in particular to not only listen to the pleas of Youngers but lend an understanding heart analysing deeply as to what is the mental trail of his family members. Decisions in case of disagreements were given keeping in mind the mental trails of family members and collective benefits of all in family. Gradually, thoughts of collective benefits, decision of head of family and understanding mental trails were replaced by individual benefits, supremacy of head of family and egoist traits of knowhow took place. Youngers were expected to listen to elders and obey their orders. Hence, in present context, "Generally, adolescents do not share their personal concerns with their parents because they believe their parents will not listen and will not understand their problems".

Present trend of family structure is shifting from joint family to nuclear family. Urbanisation, modernisation and lack of tolerance are few of the reasons. 10% civil cases filed are of family disputes (Daksh Study, 2016). Individuals have greater freedom of speech and action but household size is decreasing with every census survey conducted. Social structure is immensely work of intellect. Gurukul was the only system of education in early Vedic period with no partiality between king's son and tiler's son and focused on teaching life skills by letting scholars have hands on experience. Skills defined occupation; and caste system came into existence only in Later Vedic Period, when birth started to define Caste system. Education and occupation were withheld from lower castes. Apparently in higher castes too, one was not free to choose his occupation. A king's son by dint of birth was to be a king. This led to social, intellectual and cultural decline and caste system is to be blamed for this. Oral

learning was replaced by books and thousands of books of Nalanda University were burnt by invaders. Amadon Hampate Ba says, “In Africa, when an old man dies, a library disappears.” A similar situation happened with Nalanda University on ablaze. The spread of Indian Culture abroad was largely the work of Nalanda University and it attracted students from China, Japan, Tibet, Korea, Mongolia and Bokhara. Nothing equals today as pioneer of cultural exchange. Political parties and technology can’t replace genuine human interface. ‘Sapiens, A Brief History of Humankind’, a book by Yuval Noah Harari explains how the size of brain has deteriorated. People have reduced analytical skills though higher technological skills than their ancestors. Books and artificial intelligence is making society progressive but to depend on them in absolute is detrimental to human civilisation and culture. Mathematician Leelawati could calculate faster than computers today and painter Raja Ravi Verma was revolutionary to bring Gods to masses, breaking ceiling of caste system. Economist John Heliban, for happiness level of nation says that income is of little significance and relationship is of larger significance; and one should focus on things that kids have in common with each other. In order to save social and educational system of nation, one should not force them to do things differently nor compare them with others. Both are being fatal.

### ***Land***

“Karl Marx, at the initial stage accepted Bernier’s theory regarding royal proprietorship of all land in India. Later he came to have realised communal ownership of land. It has been ably shown that Marx recognised three forms of land tenure in India. i) Communal property the original form of tenure which had survived in certain Indian villages; ii) Private property in the region south of the Krishna river which had not come under British rule; iii) Feudal property in areas such as Oudh where tax collectors had developed into feudal land holders on account of weakness in the central government. Of these, first two relates to ancient India”. Ancient times has weak evidence of royal ownership of land but early medieval times have strong evidence of royal ownership of land as well as some kind of feudal property in land ownership. The Constitution of India made Property Right as one its Fundamental Rights and it stayed thus till 1978. However, after much debates in court rooms; with 44th Amendment Act, 1978, Property Rights was made a legal right. For Fundamental Rights are core values for human development and stands unaltered in test of time.

Excess land parcels from zamindars were taken under Land Ceiling Act. Land Acquisition Act 1894 didn’t give fair compensation and lacked transparency in process. Hence, in 2013; it was replaced by Right to Fair Compensation and Transparency in Land Acquisition, Rehabilitation and Resettlement Act, 2013. The Real Estate (Regulation and Development) Act, 2016 is a new feather added to deal with land development. All regulations put together haven’t lessened the number of litigations. As per Daksh Study conducted in 2016, Property disputes account for 66% of litigations. Where is India heading to is a big question. Number of homelessness and housing shortage is increasing with every census conducted. Land regulations have made life easier but for rich and educated strata of society. The story of survival of poor is at stake.

### ***Justice and Governance***

Justice and Governance in land of India; where stories of just kings like Raja Shivi, of ancient times who gave away equal pound of his flesh to a pigeon in name of justice; is being tested on Global platform ever with increasing rapes cases. Justice and governance in ancient India was characterised by high level of accountability. Best practices of governance then were Ram Rajya, Vidur Neeti and Chanakya Neeti. Chanakya says, “A debt should be paid till the last penny and an enemy should be destroyed without a trace.” Sense of civic responsibility was high at individual level and in joint family, each members were accountable for well-being of others. Women during Vedic period had say in judicial affairs and governance. During medieval period, with every new dynasty and changing political system, people were less accountable for well-being of each other. British Era in India was an era of resistance where individuals looked for affirmation from others. Thinkers, philosophers and reformists like Raja Ram Mohan Roy, Vidya Chandra Sagar initiated reforms at social, cultural and intellectual levels.

Today in free India, the Constitution of India is magna carta of Justice and Governance, though non comprehensive to common man and with loopholes for lawyers to play arounds with sentiments of people. The Constitution of India till 2017, guaranteed reservation to lower caste, while promotion was purely based on eligibility. However, in April 2018; bill for promotion based on caste system was passed by the Indian Parliament and reservation in promotion policy is established until next required amendment which is unlikely to take place in near future. The brighter side of such Governance System is that people are given chance but sensibility to use power rightly should be inculcated in people being promoted based on caste system. Quality of life in free India is no doubt better than slave culture of medieval India. ‘No detention policy’, abolition of Triple Talaq are golden feathers added to the Judicial history of India.

However, India must work harder to climb up the ladder of World Governance Index (WGI) and needs to perform outstanding in all six indicators of WGI i.e. voice and accountability, political stability and absence of violence, government’s effectiveness, regulatory quality, rule of law and control of corruption.

### ***Foreign Policies***

Tracing through the Foreign Policies of India in different time frames, Kautilyan Foreign Policies are timeless in many ways. Be it in bilateral relations where both present(short) advantages and future(long term) advantages are taken into account or of warfare which have to be good counsel or diplomacy. India being the dominant rule under British Government, didn’t have any foreign policies of its own. In 1921, All India National Committee passed a resolution saying that ‘present government of India in no ways represent Indian opinion.’ Indian Congress made external relations for struggle of Independence. Congress by resolution of 1930, disassociated itself from British policy of involvement of World War II. India even before Independence, adopted the policies of anti-power and anti imperialism.

Pt. Nehru, in his speech talked of policy of non-alignment and non-involvement as basic principles of foreign policy. Different Governments formulated foreign policies

based on spirit of time, keeping policy of non-alignment and non-involvement as core. Present Government has adopted some promising policies like ‘Neighbourhood First Policy’. However, present Government keep mixing International Relations and Public Relations. India tried to establish good relations with Nepal and Pakistan overlooking Kautilya Foreign Policy where it says neighbours are enemies. Indeed, as per Kautilya Foreign Policy; India shall focus more on China and Afganishtan. Indian Government shouldn’t have spoken for Madhesis in Nepal or expressed displeasure on the Constitution of Nepal, publicly. Besides, India tried to play a role in toppling the K.P. Oil Regime in Kathmandu. All the above, gave wings to China to make in-roads into Nepal. Bhutan too felt offended and used by India, on the Doklan issue.

However, present Government led by Mr. Narendra Modi has put India on a Global Platform to a greater extent than all other previous Governments by his constant business ties, foreign visits, invitations to delegates, and agreements between neighbouring states. Kashmir problem is a long standing problem of India since Independence. But India can’t declare war on Pakistan Occupied Kashmir (POK) nor can it give it away to Pakistan for sovereignty of nation. India will have to adopt a policy of good faith like Chandragupta, guided by Kautilya adopted to acquire good faith of people of Nanda Dynasty; and establish Magdha dynasty. Indian Government have to be critical about foreign policies of different eras, learning from the mistakes of the past; and tackle delegates and use speech diplomatically on Global Platform.

### ***Environment***

Stories of survival of environment will be fruitful, if rich people of India stick to the practice of Greendex and sustainability while using resources; and Government focus more on sensitising people and doing things for environment instead of only forming policies and making Acts for Environment. Besides, stories of Chipko Movement, protest by local (Bishnois), Santhal Andolan of pre-independence era and concept of holy land, river and animals; nature worship and symbolisation of nature of ancient literature are made into everyday lore of common people. Way of life and culture of India is largely responsible for sustainability.

### **India in Rat Race of Sustainability**

‘Our Common Future’ of Brundtland Report made words, ‘Sustainable Development and Sustainability’ into commonly used words. Though way of life of Indians since then, had only resulted in depletion of forest cover. Forest Survey of India, 2015; reported of increase in forest cover due to afforestation. However, plantation and afforestation can’t replace diverse nature of forests. Similar is the case of mangrove, water table, climate change and human progress. All the above resultants are in name of development.

However, there are visionaries, activists, educationists whose lifestyles and attitudes govern the sustainable approach for resource management. Stories of Silent Valley-Social Movement started in 1973 which later in 1984 gave valley, the status of National Park. Narmada Bachao Andolan, River Rally, candle march and protest for social injustice happening in an around are rays of hope with the Constitution of India as fulcrum.

Besides, India in rat race of sustainability and race for quick transfer of information and wisdom; often wrongly inform and educate young generations through text books and social media. Maslow's theory of Motivation is a common subject in text book of school kids in India today. It's represented in a triangle where one climbs the upper layer after fulfilment of lower needs in the hierarchy. However, Maslow never used a triangle to represent his theory. Steven writes, "In summary, from our review of Maslow's theory, we gleaned five key ideas that guided our content analysis: (a) human beings are motivated by a hierarchy of needs; (b) preconditions and cognitive needs exist that affect human motivation; (c) needs are organised in a hierarchy of prepotency in which more basic needs must be *more or less* met (rather than all or none) prior to higher needs; (d) the order of needs is not rigid but instead may be flexible based on external circumstances or individual differences; and (e) most behaviour is multi motivated, that is, simultaneously determined by more than one basic need."

### **Conclusions and Cultural Sustainability: Way Ahead**

Cultural Sustainability of India comes from great men and great thoughts. A well-dressed person may be called a gentleman but well dressed soul is a prophet or great man; the originator of great thoughts like Vivekananda, Raja Ram Mohan Roy or Raja Shivi. Great Thoughts, and Vedas being collection of great thoughts; Indian Philosophy and activities are responsible for cultural sustainability of India.

People added or intermingled with verses, contaminating it. India needs to look at and analyse; subjects she is teaching to her Young generation. Philosophy of Vedas was not of caste system but was based on karma. Brahmins made caste system based on birth for their own benefits and ill thoughts crept into the society, and this is the main story. Greatness is the transformation of man by dint of thoughts. So the world should be aware of thoughts, and ways it prevail in social system. If Physics is the material science, metaphysics starts the science of thoughts. Photon is the finest particle in material science and if photon is divided tending to infinity, it will turn into thoughts. Hence, the impact of thought is grave. Indian Culture survived and is thriving only due to metaphysics of thoughts. Hence, India can start to thrive with Indian Philosophy as the base of development.

Secondly, social inclusion and family bond should act as gateway to journey of development. Human Development Index, World Governance Index and Environmental Performance Index should all include social inclusion and mass participation as one of the indicators. Education alliance, establishment of great Universities like Nalanda University of Global importance for cultural and intellectual exchange shall be given *more* importance than military alliance.

Thirdly, hierarchy of needs; for Cultural Sustainability can better be defined by horizontal layers of needs with few or all overlapping in different or same quantum. Hierarchy of needs, can be with respect to mood, circumstance, time, person, social interaction, economy, knowledge, wisdom, theory of relativity and other factors. The students instead of learning by heart Maslow's theory, can derive conceptual theory for testing it scientifically at later stage. East is famous for thoughts and West for science. Which is better off, still remains a matter of discussion after centuries. Thought is mother of science. Science originated from thoughts. Nowadays, thought is demising,

leading to downfall of literature. Its time to save our great literature. We shouldn't forget mother the literature, and our motherland India.

For Sustainability, we need to make our mind finer, then only we can realise physics or metaphysics.

## References

Jamison, S.W., Witzel, M. (1992). *Vedic Hinduism*. Harvard University: ResearchGate.

Jerome, Dr. Nyameh (2013). *Application of the Maslow's hierarchy of need theory; impacts and implications on organizational culture, human resource and employee's performance*. Department of Economics Taraba State University Jaling, Nigeria: International Journal Of Business and Management Invention.

Wininger, R Steven (2010). *Assessing Coverage of Maslow's Theory in Educational Psychology Textbooks: A Content Analysis*. Western Kentucky University. ResearchGate.

Sihag S. Balbir (2007). *Kautilya On Administration Of Justice During The Fourth Century B.C.* : Journal of the History of Economic Thought.

Hui, C. and Triandis, H. (1985). 'Measurement in Cross-Cultural Psychology: A Review and Comparison of Strategies'. Journal of Cross-Cultural Psychology, Vol. 16.

Medora, N. P., Larson, J. H., and Dave, P. B. (2000). 'East- Indian College Student's Perceptions of Family Strengths'. Journal of Comparative Family Studies, Vol. 31, pp 408–424

Sharma Ram Sharan (1991). 'Aspects of Political Ideas and Institutions in Ancient India'. Motilal Banarsidass publi..

Nehru Pt. Jawaharlal (1992). 'The Discovery of India'. Oxford University Press.

**Contact email:** [rupasingh20@gmail.com](mailto:rupasingh20@gmail.com)





## ***Recent Developments in Russia-Japan Energy Relations***

Svetlana Vassiliouk, Meiji University, Japan

The Asian Conference on Sustainability, Energy & the Environment 2018  
Official Conference Proceedings

### **Abstract**

The Russian government has recently elevated the “Asia dimension” in its national energy strategy, viewing Asia-Pacific as the most attractive market due to the high energy demand, stable energy prices, and various business opportunities for Russian energy suppliers. Furthermore, Russia’s authorities realize the importance of attracting international financial and technological assistance for the development of the rich energy base and infrastructure in the remote areas of Eastern Siberia and the Far East. To achieve these goals, boosting energy cooperation with its partners in the Asia-Pacific, particularly Japan (the region’s second largest economy and one of the world’s top energy consumers) is crucial. This paper addresses recent major developments in Russia-Japan energy relations, focusing on the two countries’ cooperation in the Russian Far East and Eastern Siberia. Given the geographical proximity, complementary economic needs, and desire to diversify their respective energy policies, Japan and Russia should naturally seek to expand their energy relations with each other. In addition to their cooperation in crude oil and natural gas, since both Japan’s and Russia’s national energy strategies emphasize the improvement of energy efficiency, promotion of renewable energy resources, conservation of energy resources, and advancement of clean technologies, it is important that they seek to expand their cooperation in these areas as well. In conclusion, the paper provides an assessment of the future prospects of the bilateral energy cooperation in the context of the two countries’ relations as a whole.

Keywords: Russia, Japan, energy cooperation, energy strategy.

**iafor**

The International Academic Forum  
[www.iafor.org](http://www.iafor.org)

## Introduction

The Russian government has recently elevated the “Asia dimension” in its foreign policy and energy strategies, viewing Asia-Pacific as the most attractive market due to the high energy demand, stable energy prices, and various business opportunities for Russian energy suppliers. Furthermore, Russia’s authorities realize the importance of attracting international financial and technological assistance for the development of the rich energy base and infrastructure in the remote areas of Eastern Siberia and the Far East. To achieve these goals, boosting energy cooperation with its partners in Asia-Pacific, particularly Japan (the region’s second largest economy and one of the world’s top energy consumers), is crucial.

Japan and Russia are natural trading partners in the field of energy due to the geographical proximity, complementary economic needs, and the drive to diversify their energy policies. For Japan, seeking to secure reliable sources for energy supplies in close proximity, Russia offers a convenient location, relatively short and secure delivery routes as well as a possibility of long-term supplies of natural and mineral resources. For Russia, it is essential to secure Japan’s long-term financial commitment and extensive technological investment, especially for the development of Russia’s Far East, Eastern Siberia, and other remote areas, in turn opening up new export markets in Asia.

Additionally, the two countries’ energy cooperation benefited from the post-Fukushima adjustment of Japan’s energy policy, leading to a shift away from nuclear power and subsequent increase in demand for non-nuclear, “clean” energy resources, including natural gas and liquefied natural gas (hereafter “LNG”). Moreover, as both Japan and Russia’s national energy strategies pursue similar goals, such as the improvement of energy efficiency, promotion of renewable energy resources, conservation of energy resources, and advancement of clean technologies to facilitate emissions reductions, the two countries began expanding their bilateral energy cooperation in these areas, in addition to their traditional trade in oil and natural gas.

### **Overview of Russia-Japan energy cooperation initiatives (prior to the Ukrainian Crisis of 2014)**

Japanese-Russian energy cooperation has been gradually improving since the materialization of the Sakhalin-1, Sakhalin-2, and related oil and gas projects in the Russian Far East (hereafter “RFE”) in the mid-1990s. In April 2009, Japan received its first LNG shipment from the Sakhalin-2 project, and in December 2009, three major Japanese companies contracted purchases of ESPO crude oil cargoes<sup>1</sup> from the export terminal at Kozmino Bay in the RFE. Since then, the Russian share of Japan’s total LNG imports has grown from 4.3% in 2009 to about 10% in 2014, thereby making Russia Japan’s 4<sup>th</sup> largest LNG supplier (after Australia, Qatar, and Malaysia). Also, Russia overtook Iran to become Japan’s 4<sup>th</sup> largest (and the top non-Middle-Eastern) supplier of crude oil, with oil shipments to Japan reaching approximately 10.13 million barrels, constituting 9% of Japan’s total crude imports in July 2010 (Maeda, 2010).

---

<sup>1</sup> ESPO crude oil cargoes are delivered via the Eastern Siberia-Pacific Ocean oil pipeline [hereafter the “ESPO oil pipeline”], which came into full operation in December 2009. The shipment of the first oil cargo from Kozmino Bay (in Primorskiy District of the RFE) took place in January 2010.

At the governmental level, a number of important energy cooperation agreements were concluded between the two countries during the same period. In 2008, the Japanese government represented by the Japanese Ministry of Economics, Trade and Industry (METI)'s Agency for Natural Resources and Energy (ANRE) signed a Memorandum of Understanding (MoU) with Russia's largest oil company Rosneft, laying ground for energy cooperation in a number of sectors related to crude oil exploration, extraction, and deliveries in Eastern Siberia and the RFE. On May 12-15, 2009, Russia's largest energy company Gazprom signed an agreement in the gas sector development with Japan's ANRE, Itochu Corporation, and Japan Petroleum Exploration Company (JAPEX). Additionally, in June 2013, Gazprom successfully completed a feasibility study on the Vladivostok LNG project with Japan Far East Gas Co. (JFG).<sup>2</sup> Upon its completion, this project is expected to make an important contribution to the stable LNG supplies from Sakhalin and Eastern Siberia to Japan and the rest of the Asia-Pacific Region (hereafter the "APR"), thereby helping diversify Russia's LNG export routes (see Map 1; Gazprom Press Release, 2011).

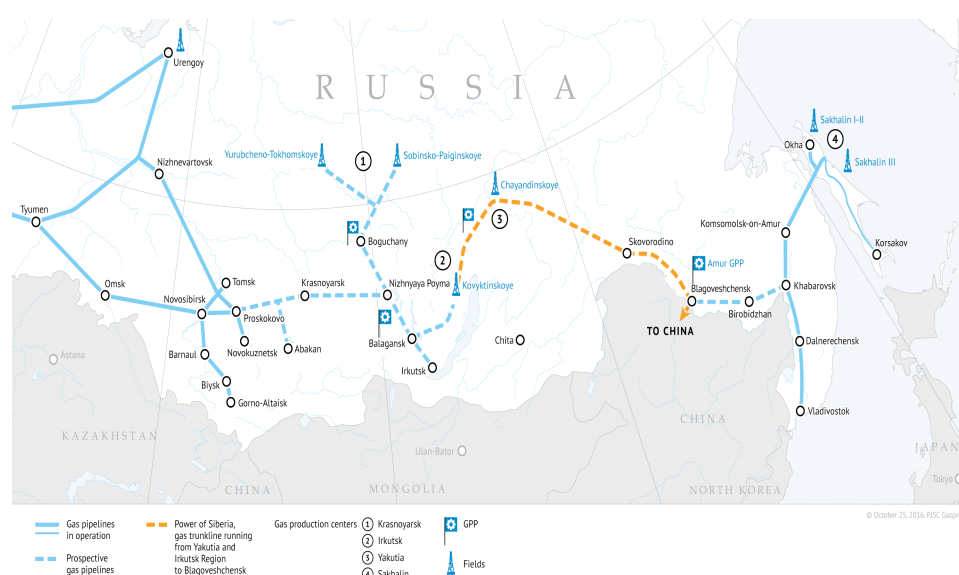

Map 1. Energy Development Projects (Natural Gas and LNG) in the RFE.  
(Source: Gazprom, 2018).

However, in spite of the increased number of new opportunities in Russia-Japan energy cooperation during this period, many of the initiatives and projects have stalled, were postponed or altogether abandoned, due to the lack of economic feasibility and financial difficulties, further exacerbated by the economic and technological sanctions imposed by the West on Russia in response to the 2014 Ukrainian Crisis. For example, in June 2015, Gazprom's Chairman Alexey Miller announced that the construction of the LNG terminal in Vladivostok was no longer a business priority; therefore, it would unlikely be realized in the near future (Vesti: Ekonomika, 2015). Furthermore, because of the remaining political hurdles and lack of trust in Japan-Russia business relations, historically only large Japanese companies capable to secure government financial and political support were able to successfully engage in joint projects in Russia.

<sup>2</sup> The Far East Gas Co. (JFG) is a company established by several Japanese firms, such as INPEX, Itochu, Japan Petroleum Exploration (JAPEX), Marubeni and Itochu Oil Exploration (CIECO).

## The Sakhalin Oil and Gas Projects

Sakhalin oil and gas development projects, which have been the most successful joint initiatives, are also among the most extensive and largest commitments supported by the Japanese government in the USSR and Russia to date (see Map 2). In the Sakhalin-1 project<sup>3</sup>, Japan is represented by a consortium of the Sakhalin Oil and Gas Development Company (SODECO), Itochu, and Marubeni corporations, holding a 30% share in total. The Japanese members of the Sakhalin-2 consortium are the Mitsui Bussan and Mitsubishi Shoji corporations, with 12.5% and 10% of the project shares, respectively. Both Sakhalin-1 and Sakhalin-2, which are among the world's largest oil and gas integrated projects, hold the extensive recoverable gas and oil reserves, the development of which has attracted tens of billions of dollars in investment.

The Japanese government has been providing financial assistance to the Sakhalin-2 project since its inauguration, particularly for the construction of the first Russian LNG terminal located in Prigorodnoye on the Aniva Bay of Korsakov District in Sakhalin Region. The Japanese Bank for International Cooperation (JBIC), along with a banking consortium of international (mainly Japanese) banks, agreed to provide a 5.3 billion-dollar package, which helped finance the final stages of the LNG construction project.



Map 2. Overview of Energy Projects in Sakhalin Island.  
(Source: Gazprom, 2015).

The LNG production from the Sakhalin-2 project at the new terminal began without delay on March 5, 2009, with the first shipment of LNG (4.8 million tonnes) reaching Japan in early April 2009. By December 2010, the LNG plant was operating at its full production capacity of 9.6 million tonnes a year, constituting 5% of the world's LNG market and about 4.3% of Japan's LNG imports. At that time, about 65% of the total

<sup>3</sup> Other international partners in the Sakhalin-1 project include the US' Exxon Mobile and India's ONGC Videsh, holding 30% and 20% shares, respectively.

capacity was contracted on a long-term basis to eight Japanese companies, including Tokyo Gas and Toho Gas, and the remaining 35% to the South Korean and the US markets.

In August 2012, the 500th cargo of Sakhalin LNG was successfully offloaded from Prigorodnoye, and by the end of 2014, the Sakhalin LNG plant produced 10.8 million tons of LNG (about 7% of global and 9% of Japan's LNG supplies) for exports to Japan, South Korea, China, Taiwan, and Thailand. In addition, from 2011, the Sakhalin-2 project started commercial production of the new "Sakhalin Oil Blend" of crude oil, which was introduced on the Asian market for the first time and was successfully delivered to Japan, China, and South Korea in 2014 (Sakhalin Energy, 2015).

The Sakhalin-1 project was also progressing successfully, aiming at the start of commercial production at its main oil and gas fields (Chayvo, Odoptu, and Arkutun-Dagi) by 2015. Furthermore, after the completion of the 1,800-km Sakhalin-Khabarovsk-Vladivostok gas pipeline, which was constructed ahead of schedule in September 2011, the Russian government announced that it would build an additional LNG terminal in the RFE in order to ship the Sakhalin pipeline gas and LNG to Japan, China, and other consumers in the APR (Sakhalin-1 Project, 2015; Gazprom, *Sakhalin-Khabarovsk-Vladivostok*, 2018).

### The ESPO oil pipeline and related projects

Other examples of successful projects with Japanese participation include the construction of the ESPO oil pipeline and development of the related regional infrastructure (see Map 3). The ESPO oil pipeline project was launched in 2004 and was divided into two construction phases. Phase 1, which focused on the construction of the 2,757-km Tayshet-Skovorodino branch to deliver around 600,000 barrels of oil a day (hereafter "bbl/day"), was completed and became operational on December 28, 2009. The first crude supply from the new oil terminal at the Kozmino Bay on Russia's Pacific Coast (near Nakhodka City in Primorskiy District of the RFE) was shipped in January 2010, thereby officially launching the ESPO Blend exports to the Asia-Pacific market.



Map 3. The ESPO oil pipeline route (as of January 2013).  
(Source: Fischer, 2018)

Phase 2 of the ESPO oil pipeline project, connecting Skovorodino with the Kozmino Bay Terminal (about 2,100 kilometers; projected capacity of 30-45 million tons/year), was successfully completed two years ahead of the planned schedule, in December 2012. At the commemorative ceremony, President Putin stressed the critical significance of this project for the regional as well as the national economy. He also declared that the project would help connect the RFE with the rest of Asia and would help deliver the ESPO blend to a large number of Russian energy partners, namely Japan, China, the US, the Philippines, South Korea, Indonesia, Singapore, Thailand, and Malaysia (Kremlin, 2015).

Since the successful launch of Phase 1 of the ESPO oil pipeline, many Japanese energy companies began seeking direct participation in the development of Russia's natural resources in Eastern Siberia and the RFE, both in the upstream and downstream sectors<sup>4</sup>. By taking part in these projects, the Japanese businesses sought to enlarge their presence in the Russian energy market and to ensure that the Russian government would maintain its commitment to the timely and successful completion of the second phase of the ESPO pipeline, which was expected to become a critical link to the energy supply route between the RFE and Japan.

In April 2008, Japan's state-run Oil, Gas and Metals National Corporation (JOGMEC) announced that it secured the rights to develop the Severo-Mogdinsky oil and gas block in Irkutsk Region (see Map 4), thereby obtaining access to Russian oil resources in Eastern Siberia. The business deal was in line with "the promotion of collaboration between Japan-Russia private enterprises outlined by 'The Japan-Russia Action Plan' adopted during the Russia-Japan summit in January 2003 and 'The Initiative for Strengthening Japan-Russia cooperation in the Far East and East Siberia' agreed by the countries' leaders in June 2007" (JOGMEC, 2010). In order to explore and develop the acquired area, JOGMEC established a joint venture with Russia's Irkutsk Oil Company (INK) by providing the latest technology for the block's seismic studies and exploration and jointly investing 95.8 million dollars in this project.<sup>5</sup>

---

<sup>4</sup> The upstream sector refers to the exploration and production (E&P) sector of energy operations and involves the searching for and the recovery and production of crude oil and natural gas. The downstream sector focuses on the refining of crude oil as well as the selling and distribution of natural gas and products derived from crude oil (such as liquified petroleum gas (LPG), gasoline or petrol, jet fuel, diesel oil, other fuel oils, asphalt and petroleum coke).

<sup>5</sup> Following the successful Putin-Abe Summit in June 2007, INK and JOGMEC formed a 51:49 joint venture ("INK-Sever" LTD) specifically to launch their joint development of Severo-Mogdinsky oil and gas block.



Map 4. JOGMEC: the ESPO oil pipeline-related projects.  
(Source: JOGMEC, 2010)

Aiming at the joint development of energy infrastructure and expansion of crude oil production in Eastern Siberia for shipments to Japan, JOGMEC established two joint ventures with local Russian energy companies in May 2009. The main purpose of the first project, established between JOGMEC and Russia's "United Oil Group Ltd" (holding 49% and 51% shares, respectively), was to carry out a five-year feasibility study and prospecting work in Russia's Krasnoyarsk Territory, Irkutsk Region, and Sakha Republic (Yakutiya). The second joint-venture, between JOGMEC and Russia's "INK-Zapad", was created to explore two additional oil and gas blocks of Bolshetirsky and Zapadno-Yaraktinsky in the same region (see Map 4). On September 24, 2013, it was reported that the second project expanded its operations and "moved to a new stage after joining of Itochu Corporation and INPEX Corporation, two major Japanese private companies, to the project as shareholders of JASSOC, which is a subsidiary of JOGMEC" (JOGMEC Press Release, 2013).

During the same period, Japan and Russia also held discussions on a number of projects for the downstream sector development in Eastern Siberia and the RFE. One such project focused on the participation of Japanese companies in the construction of Rosneft's refinery (planned capacity of 200,000-400,000 bbl/day) at the final destination point of the ESPO oil pipeline. In November 2009, JOGMEC and INK signed a feasibility study agreement to develop gas-to-liquid (GTL) capacity in Eastern Siberia and the RFE (Russia and CIS Oil and Gas Weekly, 2009, p. 15).

These joint energy projects have been not only mutually beneficial for the economies of Japan and Russia but also critically important for Russia's regional development. While utilizing Japanese investment and technological support, the Russian government granted Japanese businesses access to the Russian downstream and upstream sectors and, in a long-term perspective, offered them other important benefits of joint development of energy resources and infrastructure development in the Russia's Far East, Eastern Siberia, and other remote areas rich in oil and gas resources. In turn, energy development in Russia's remote areas was helping boost their transport and service infrastructure, and economic development of the areas as a whole.

In addition to the aforementioned projects focusing on the traditional sectors of energy cooperation, Japan-Russia cooperation has been growing in other fields, such as nuclear and renewable energy resources as well as environmental protection, energy efficiency and conservation. Since Russia lacks experience in these areas (with exception of the nuclear sector), Japan is seen as an important partner that could contribute its expertise and advanced technology in such projects.

Prior to the March 2011 Fukushima nuclear disaster in Japan, Japan and Russia had been expanding their ties in the nuclear energy sector as well. In May 2009, Japan and Russia signed an agreement on cooperation in peaceful use of atomic energy, which stipulated that Russia would deliver supplies of low-enriched uranium to Japan, while Japan would supply Russia with advanced nuclear power plant technology in exchange. It also envisioned increasing the share of Russia's presence in Japan's nuclear energy market from its current 15% to 25% in the near future (World Nuclear News, 2009).

The Fukushima nuclear accident that followed the Great Eastern Earthquake in Japan's Tohoku region on March 11, 2011 brought a new set of realities in Japan's energy policy as well as in the two countries' energy relations. At the end of 2011, only 16 out of 54 existing nuclear plants were still operating in Japan, and currently all but 5 of the nuclear reactors are offline. While it is politically and economically difficult to envision nuclear power in Japan being completely phased out, its share will likely remain relatively small in the total power general mix. Therefore, in order to compensate for the lost power generation due to the decline in its nuclear power sector, Japan needs to increase supplies of other primary energy resources, such as oil, gas and coal, preferably from reliable suppliers in its close proximity, such as Russia.

### **Key developments in Russia-Japan energy relations since 2014**

In late 2014, in response to Russia's interference in Ukraine and annexation of Crimea, the US and the rest of the Western nations imposed economic, trade, and technological sanctions on Russia. Japan, as a member of the G-7 group, also introduced a package of sanctions, albeit a mild one, placing various restrictions on a number of Russian businesses, especially those operating in Crimea. The Western sanctions have undoubtedly hurt Russia's economy, including trade, technological and economic cooperation, particularly in the field of energy. The difficult economic situation in Russia was exacerbated by a significant drop in energy prices that further undermined Russia's economic growth and put in jeopardy the large-scale energy development projects. Average Brent Crude Oil price, which stood at \$109/bbl in the first half of 2014, fell by more than 70% to about \$31/bbl by January 2016 (EIA, Brent Spot Price, 2017). Although oil prices have recently recovered to the levels of \$75-80/bbl, the aforementioned two factors have simultaneously threatened Russia's chances for energy exploration, development, and investment, especially large-scale projects domestically and abroad, including several Russia-Japan energy projects and initiatives.

In spite of the above challenges, Russia remains a global energy superpower and hence an important energy partner for Japan and other Asian partners. Presently, it is the world's top natural gas exporter and the second largest natural gas producer (with the export volume of 197.7 billion cubic meters [bcm] and the production volume of



598.6 bcm based on the 2015 estimates). It is also the world's top oil producer and second largest oil exporter (at the rates of 10.55 million bbl/day and 5.116 million bbl/day, respectively, based on the 2016 estimates) as well as the world's second largest exporter of refined petroleum products (at the rate of 3.133 million bbl/day based on the 2014 estimates) (CIA World Factbook, 2018).

Because of Japan's participation in the Western sanctions regime vis-à-vis Russia and due to Russia's (although limited) retaliating measures, there has not been many new, significant developments in the two countries' energy relations aside from the joint projects already onstream. However, in 2016, Russia and Japan have entered a new stage not only in their energy cooperation but also in their bilateral relations as a whole. In 2016, PM Abe and President Putin held three important meetings (two summits in Sochi and Yamaguchi and a meeting at the Eastern Economic Forum<sup>6</sup> in Vladivostok), during which they discussed progress in their countries' ties in various areas, including joint energy and infrastructure development in the RFE and Eastern Siberia. The ultimate goal of these frequent meetings, especially for Japan, was to advance bilateral negotiations on the Kuril territorial dispute, aiming at signing a peace treaty to formally settle the two countries' WWII grievances.<sup>7</sup>

During the same year, a number of important meetings and visits by the two countries' ministers in charge of trade, energy, and cooperation with each other also took place on a regular basis. These meetings further solidified the two countries' commitment to the acceleration and expansion of their economic ties, culminating in the agreement on about 100 bilateral projects and the establishment of the joint one-billion-dollar fund to help facilitate financing of some of those projects.<sup>8</sup> Furthermore, at the summit meeting in Sochi on May 6, 2016, Japan announced it would be launching a "new strategy" vis-à-vis Russia focusing on joint economic cooperation in eight areas, including energy, developing industries and export bases in the RFE, and cooperating on advanced technologies (at an estimated cost of more than one trillion yen, or 9.6 billion dollars). Among the proposed projects for energy cooperation, the two countries' leaders revisited the construction project of a petrochemical plant near Vladivostok (at an estimated cost of 600 billion yen) as well as development of oil and natural gas in Sakhalin, Siberia, and the Arctic Sea area (Japan Today, 2016).

The progress in the eight-item cooperation plan was later confirmed during the St. Petersburg International Economic Forum in June 2016 by Japan (represented by

---

<sup>6</sup> In September 2015, President Putin personally launched the Eastern Economic Forum in Vladivostok, thereby reiterating Russia's determination to accelerate the development and export of natural resources from the RFE to the countries in the Asia-Pacific. The Forum has become an important annual event held every September with personal attendance by the Russian president.

<sup>7</sup> Japan and the Soviet Union/Russia have been entangled in the territorial row over the four southernmost Kuril Islands of Shikotan, Kunashir, Iturup, and the Habomai (the "Northern territories," as Japan calls them, or the "Southern Kurils," as Russia refers to them) since the end of WWII. The territorial dispute, which has dominated the political, economic, and even cultural relations between Russia and Japan for more than a half century, serves as the main reason for the two countries failing to settle their borders. It also prevented them from signing a peace treaty following World War II.

<sup>8</sup> The joint fund, comprised of 500 million dollars provided each by the JBIC and the Russian Direct Investment Fund (RDIF), will help finance a large number of joint projects in Russia. The two entities have been in partnership since 2013 to provide financial assistance to Japanese companies doing business in Russia (see Gale, 2016).

Hiroshige Seko, Minister of Economy, Trade and Industry and also for Economic Cooperation with Russia) and Russia (represented by Maxim Oreshkin, Minister for Economic Development and President Putin's Special Representative for Trade and Economic Cooperation with Japan). Minister Seko also visited Russia on November 2-6 to inaugurate and, together with Russian Energy Minister Alexander Novak, to chair the first meeting of the Japan-Russia Energy Initiative Council. During the council meeting, it was announced that three working groups, focusing on bilateral cooperation in hydrocarbons, energy efficiency and renewable energy, and nuclear energy, will be established to oversee bilateral projects in these areas. These new developments at the government and institutional levels suggest that Russia and Japan have reached a new level in their energy cooperation and have diversified their cooperation in various sectors, not limited to traditional oil and gas projects.

In the oil sector, Russia-Japan energy ties greatly benefited from the increase in the crude oil deliveries through the ESPO oil pipeline to Asian customers, after the pipeline oil-pumping capacity was expanded from 50 to 58 million tons of crude oil per year in 2014. Also, there has been a consistent (6.6-fold) increase in Russia's crude oil supplies to Japan between 2005 and 2016 (EIA, Russia Reports, 2005 and 2016). In the gas sector, in addition to the continuing development of Russia's pipeline gas capacity and infrastructure in the RFE, the Russian government focused on boosting Russian LNG exports in the APR. For example, deliveries of Russian LNG from the Sakhalin-2 project to Japan (which recently became the world's largest buyer of LNG), reached 10.8 million tons by the end of 2014 and currently occupy a 9% share in Japan's total LNG imports.

Among other bilateral projects that have been realized as a result of a new momentum in the two countries' relations are the Yamal LNG (led by the Russian largest independent natural gas producing company "Novatek" and located in Yamalo-Nenets Autonomous Okrug, north of the Arctic Circle) and the Sakhalin LNG expansion projects. Japan (represented by the joint venture of engineering firms Technip, JGC and Chiyoda) was participating in Russia's Yamal LNG project prior to the 2014 Ukrainian crisis. Presently, the project is still an undergoing venture, which includes the construction of additional two LNG trains, export and other facilities, reaching the capacity of 5.5 million tons/year in the future, in which the Japanese firms will continue playing an important role in providing engineering expertise and possible future financial investment, albeit subject to the sanctions' limitations. The ongoing LNG project and the planned Arctic LNG-2 project will also be supported by the JBIC's financial assistance offer, which was announced in late 2016.

Another recent proposal for Japan-Russian energy cooperation came from Gazprom, which, along with its Sakhalin-2 partners, announced it would build an additional Sakhalin LNG platform in order to increase LNG exports to Japan starting from 2022. In his interview with the Nikkei Asian Review, Gazprom's Deputy Chairman Alexander Medvedev declared, "if there is enough demand in Japan, we will make the expansion of this business a top priority, creating a pillar for future cooperation between Russia and Japan" (Ikeda, 2016). Gazprom also announced that, in response to "strong, repeated requests" from Japanese business and political leaders, it would be conducting a feasibility study jointly with the Japanese partners for the gas pipeline construction mega-project connecting Sakhalin to Japan and would revisit the shelved

plan to build an LNG plant in Vladivostok, which would serve as the “export hub to Japan” upon its realization (Ibid).

While technological assistance and capital investment offered by Japan is very much welcome by Russia, the Japanese government and financial institutions have to operate carefully in Russia in order not to violate the West’s sanctions regime that Japan is part of. Belov (2016) observes that “elsewhere, from Yamal, to Tatarstan, to Yakutia doors are opening for Japanese investors, and opening wide. With the carrot of a potential territorial resolution in hand – and with Tokyo seemingly willing to splinter the U.S. strategy of isolation – Russia is operating from a relative position of strength”. Indeed, the main reason for the Japanese government’s willing to take the risk of possible criticism from the rest of the G-7 group, particularly the US, is that it wants to make progress in the Kuril territorial negotiations with Russia. In late 2016, it was reported that the Japanese government, hoping to pave the way for a breakthrough in the territorial row negotiations with Russia, began actively urging Japanese businesses to invest in Russia, specifically in the projects under Abe’s “eight-point economic plan.” In spite of this pressure, it remains a difficult task to attract large Japanese private-sector investment due to various risks associated with doing business in Russia, which, in addition to the cost-benefit uncertainties, include the unpredictable investment environment, widespread corruption and red-tape, changeable legal system, and the fallout from the Western sanctions (Umekawa and Sieg, 2016).

In spite of a considerable potential for Japanese-Russian energy cooperation, the number of new concrete joint projects and initiatives that have been, or are in the process of being, fully realized remains relatively small. The most difficult problems affecting the prospects for the expansion of the two countries’ energy ties stem from the Western economic and technological sanctions, unstable crude oil prices, and the unsettled political issues, such as the Kuril territorial dispute and the absence of a peace treaty, undermining a full normalization of the two countries’ ties. Furthermore, Russia-Japan energy cooperation in the traditional, fossil-fuel sectors may also suffer as a result of the future adjustments in Japan’s energy demand due to the shift away from overreliance on fossil fuels and a possible return to a larger nuclear energy share, which was proposed in the recently adopted energy plan of the Japanese government (Yamaguchi, 2018).

### **Future prospects in Russia’s energy cooperation with Japan**

The future Japanese-Russian energy projects will most likely be related to the existing large-scale undertakings in Sakhalin, the RFE, and Eastern Siberia. In addition, a number of new opportunities for potential bilateral cooperation will likely be found in the fields of energy conservation and efficiency, promotion of non-fossil and renewable energy resources, and advancement of clean energy technologies.

Since the launch of Japan’s “new approach” aiming to boost economic ties with Russia, Japan’s and Russia’s governments as well as their business and industry leaders have been revisiting several large-scale, ambitious mega-projects, namely the construction of the Sakhalin-Japan gas pipeline and Sakhalin-Japan power grid. Both projects have been considered in the past but had to be abandoned due to their prohibitive costs, seismic and environmental concerns, and the impact on the regional

fishing industry. However, after Russia and China concluded their historic, multibillion-dollar gas deal in May 2014<sup>9</sup>, a group of Japanese lawmakers from the ruling coalition parties, the LDP and Komeito, began lobbying for the construction of a gas pipeline to deliver the Sakhalin gas to Central Honshu. The proposal called for the construction of a 1,500-km pipeline with the annual capacity of 20 bcm at the cost of approximately 7 billion dollars (Eurasia News Online, 2016). So far, there has not been any progress on this initiative due to the uncertainty over its profitability and the lack of interest from Russia that seemed to favor a more economically and logistically attractive option of the LNG deliveries to Japan. Furthermore, in addition to the project's high cost estimates, the Japanese business leaders remain wary of overreliance on Russia for gas supplies, instead preferring the LNG option, especially because of considerable investment in the existing LNG receiving facilities in Japan.

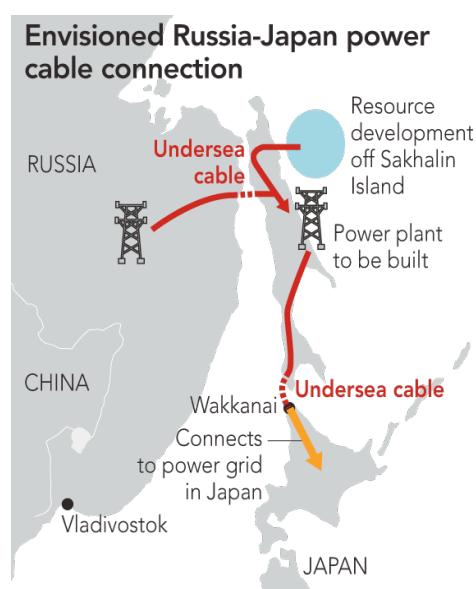

Map 5. “Envisioned Russia-Japan power cable connection”.  
(Source: *Eurasia News Online*, 2016).

Another multibillion-dollar mega-project involves the construction of the electric power grid connecting Sakhalin and Japan by an underwater electric cable (see Map 5), which could further connect the two countries to China and South Korea as well, creating the so-called “Asian Supergrid.” This project, however, seems to be even less likely to be materialized in the near future. In addition to the high price tag, it would require legal and logistical adjustments in Japan’s electric grid system to be able to accept Russian electricity and, as with the Sakhalin-Japan gas pipeline project, it would also result in Japan’s energy dependence on Russia, which, along with the outstanding political problems, would only increase Japan’s risk and vulnerability vis-à-vis its northern neighbour.

<sup>9</sup> On May 21, 2014, Russia’s Gazprom and China’s CNPC concluded a long-term agreement at the unprecedented cost of 400 billion dollars that envisions deliveries of 33 (eventually up to 38) bcm/year of pipeline gas for the period of 30 years that will be transported by the “Power of Siberia” pipeline from Russia to China starting in 2019. This agreement also stipulated the multibillion-dollar additional construction of a massive gas infrastructure in Russia’s Eastern Siberia to support this commitment.

## **Conclusion: Impact of Russia's energy "pivot" to Asia on its overall relations with Japan**

In 2012, when Putin and Abe became the Russian president and the Japanese prime minister for the third and second term, respectively, Russia and Japan have entered a new stage in their relations. In spite of the continuing economic and technological sanctions placed by the West on Russia in response to the 2014 Ukrainian crisis, their impact on the two countries' economic ties and trade relations has been relatively mild, as their bilateral cooperation continues to steadily progress.

Growing Japan-Russia economic ties and energy cooperation has been a welcome development in the two countries' relations as a whole. The most successful developments in the bilateral energy cooperation to date include the inauguration of the Prigorodnoye LNG plant in March 2009 under the Sakhalin-2 Project; the December 2009 launch of the Kozmino Bay oil terminal and the December 2012 completion of Phase 2 of the ESPO oil pipeline project; the completion of the Sakhalin-Khabarovsk-Vladivostok gas pipeline in September 2011; joint energy development projects in Eastern Siberia with JOGMEC; and the expansion of Russia's LNG production capacity for the shipments to the APR. These projects serve as important milestones, helping bring Japanese-Russian energy cooperation to a new level, marking the beginning of large-scale energy exports from Russia to Japan, and opening Russia's access to Asia-Pacific energy markets.

Based on the close linkage between politics and economics in the two countries' relations, it is plausible to argue that through deeper economic integration and energy cooperation, Japan and Russia will be able to improve their political ties as well. Both Japan's and Russia's leaders today agree that the absence of a peace treaty in their relations, in Putin's words, is "abnormal," and that they need to place a high priority on signing a peace treaty in the near future as the key prerequisite for the full normalization of their relations (Japan Times, 2013). Minister Seko, during his interview with the Financial Times in December 2016, stressed the importance of Japan's continuing expansion of its economic ties with Russia, stating that Japan prefers "a win-win relationship. Without thinking about the Northern Territories too much, we want to set up economic projects of benefit to Japan. But if both countries can work together and develop a really good relationship, then it'll help make a better environment for PM Abe... to conduct Northern Territories negotiations" (Harding, 2016).

It is crucial for the two countries to continue advancing their bilateral relations in various areas, especially in the strategically important energy sector, in order to create opportunities to deepen their dialogue in search of timely, effective, and mutually acceptable solutions to their outstanding problems, including the Kuril territorial dispute. Because Russia and Japan are the key players in the world energy market, particularly in the APR, their successful energy collaboration not only would serve their respective economic and energy needs but also would improve their political relations. This, in turn, would contribute greatly to the strengthening of energy security, cooperation, and political stability in the APR as a whole.

## References

Belov, Andrey. (2016). Over a Century of Political and Industrial Changes: How to Overcome Path Dependence in Japan–Russia Trade? *The Journal of Comparative Economic Studies*, Vol.11, pp. 83–105. Retrieved from [http://www.s.fpu.ac.jp/u-abcpage/Belov%20Path%20Dependence%20\(Sep-16\).pdf](http://www.s.fpu.ac.jp/u-abcpage/Belov%20Path%20Dependence%20(Sep-16).pdf).

CIA Homepage. (May 29, 2018). *CIA World Factbook: Russia* (Economy and Energy statistics). Retrieved from <https://www.cia.gov/library/publications/the-world-factbook/geos/rs.html>.

EIA (US Energy Information Administration) Homepage. *Russia Reports* (for the years of 2005 and 2016). Retrieved from <https://www.eia.gov/beta/international/analysis.cfm?iso=RUS>.

EIA Homepage. (November 14, 2017). *Brent Spot Price*. Retrieved from <https://www.eia.gov/dnav/pet/hist/LeafHandler.ashx?n=pet&s=rbrte&f=m>.

*Eurasia News Online*. (November 3, 2016). Japan Mulls Plugging into Sakhalin's Electricity Grid. Retrieved from <https://eurasia-news-online.com/2016/11/03/japan-mulls-plugging-into-sakhalins-electricity-grid/>.

Fischer, Ewa. (2018). Completion of the ESPO oil pipeline connects Siberia to the Pacific Ocean. *The Centre for Eastern Studies (OSW) Homepage*. Retrieved from <https://www.osw.waw.pl/en/publikacje/analyses/2013-01-09/completion-espo-oil-pipeline-connects-siberia-to-pacific-ocean>.

Gale, Alastar. (December 15, 2016). Russia, Japan Plan \$1 Billion Fund for Equity Investments. *The Wall Street Journal*.

Gazprom Homepage. (2018). *Eastern Gas Program: Developing gas resources and shaping gas transmission system in Eastern Russia*. Retrieved from <http://www.gazprom.com/about/production/projects/east-program>.

Gazprom Homepage. (2018). *Sakhalin – Khabarovsk – Vladivostok*. Retrieved from <http://www.gazprom.com/about/production/projects/pipelines/active/shvg/>.

Gazprom Homepage. (2015). *Map of the Sakhalin Projects*. Retrieved from <http://www.gazprom.com/about/production/projects/deposits/sakhalin3/>.

Gazprom Homepage. (January 17, 2011). Gazprom Press Release. *Gazprom and Japanese Agency for Natural Resources and Energy Consider Cooperation in Eastern Russia*. Retrieved from <http://www.gazprom.com/press/news/2011/january/article107602/>.

Harding, Robin. (November 6, 2016). Japan and Russia talk economics ahead of summit over disputed islands. *The Financial Times*.

Ikeda, Motohiro. (September 26, 2016.) Gazprom looks to expand LNG output in Russian Far East. *Nikkei Asian Review*.

*Japan Times*. (February 22, 2013). Putin: Lack of treaty 'abnormal'. Retrieved from <http://www.japantimes.co.jp/news/2013/02/22/national/putin-says-absence-of-japan-russia-peace-treaty-is-abnormal/#.Uq0OI9IW16A>.

*Japan Today*. (October 9, 2016). Japan eyes Y1 tril economic cooperation for Russia.

JOGMEC Homepage. (October 25, 2010). *Japanese-Russian joint-ventures find oil and gas in Irkutsk Region*. Retrieved from <http://www.jogmec.go.jp/english/news/release/release0058.html>.

JOGMEC Homepage. (September 24, 2013). Press Release. *New stage of JOGMEC-INK joint project in Eastern Siberia*. Retrieved from <http://www.jogmec.go.jp/english/news/release/release0058.html>.

Kremlin Homepage. (July 20, 2015). Events. *Launch of the Second Stage of the Eastern Siberia-Pacific Ocean Pipeline*. Retrieved from <http://en.kremlin.ru/events/president/news/17187>.

Maeda, Risa. (September 30, 2010). Japan almost doubles Russia crude imports in August. *Fox Business News*.

*Russia and CIS Oil and Gas Weekly*. (2009). No. 47 (913).

Sakhalin Energy Homepage. (2015). *History*. Retrieved from <http://www.sakhalinenergy.com/en/company/history.wbp>.

Sakhalin-1 Project Homepage. (2015). *About Phases*. Retrieved from [http://www.sakhalin1.com/Sakhalin/Russia-English/Upstream/about\\_phases.aspx](http://www.sakhalin1.com/Sakhalin/Russia-English/Upstream/about_phases.aspx).

Umekawa, Takahashi, and Sieg, Linda. (November 3, 2016). Japan nudges wary firms to invest in Russian to help resolve islands dispute. *Reuters*.

*Vesti: Ekonomika*. (June 26, 2015). Miller: O Kitae, Vladivostok SPG i Ukraine (in Russian) [Miller: About China, Vladivostok LNG and Ukraine?]. Retrieved from [www.vestifinance.ru/articles/59309](http://www.vestifinance.ru/articles/59309).

World Nuclear News. (May 12, 2009). *Russia and Japan sign cooperation accord*. Retrieved from [http://www.world-nuclear-news.org/NP-Russia\\_and\\_Japan\\_sign\\_cooperation\\_accord-120509.html](http://www.world-nuclear-news.org/NP-Russia_and_Japan_sign_cooperation_accord-120509.html).

Yamaguchi, Mari. (July 4, 2018). Japan Oks ambitious nuclear energy target, plutonium reuse plan. *Japan Today*.





## ***Desirable Specification of Vetiver Grass Roofing Making Machine***

Kridsada Saisang, Suranaree University of Technology, Thailand  
Krawee Treeamnuk, Suranaree University of Technology, Thailand  
Tawat Treeamnuk, Suranaree University of Technology, Thailand

The Asian Conference on Sustainability, Energy & the Environment 2018  
Official Conference Proceedings

### **Abstract**

This research objective was to study the appropriate mechanism and powertrain of the machine for the reducing of handwork process and time in grass roofing material manufacture. The SolidWorks 2016 Software was used to design and determine the limitation of mechanisms by use the Motion Studies function of the software. The analyzed data were calculated to determine the size of actuator and power required for the driving of machine. The result found that the designed machine required a 6 bars of air supply pressure and could has 5 mainly components such as (1) Grass sheet folding mechanism driven by the 63 mm diameter of pneumatic cylinder with the 28.08 liters/min air supply. (2) Grass sheet pressing mechanism powered by a couple of 40 mm diameter of pneumatic cylinder with the air supply 15.06 liters/min. (3) The wood rod frame gripping mechanism driven by the 12 mm diameter of pneumatic cylinder with the air supply 0.66 liters/min. (4) The grass sheet feeding mechanism for the sewing process used the 50 Watts electric gear motor and (5) Electric sewing machine model GK26-1A to seam the grass sheet with the wood rod frame.

Keywords: Vetiver grass, Grass roofing, Semi-automatic machine

**iafor**

The International Academic Forum  
[www.iafor.org](http://www.iafor.org)

## Introduction

Vetiver is a Thai local grass that grows easily in all regions of the country. Thai people knew the usefulness of vetiver for a long time such as, the using of vetiver leaves in a soil mulching to maintain the moisture for planting, the using of vetiver leaves as a material in handicrafts. Currently, they are many innovations about the usefulness of vetiver leaves for example, the planting materials, decomposing plant pots, the insulator from vetiver leaves for construction materials and the multipurpose particleboard etc. Another important of vetiver leaves usefulness is a roofing material (called vetiver roof in Fig.1) because it is a locally available material. If the vetiver roof was produced by the proper method the roof has been durable and can prevent the leakage of rainwater very well and it is an excellent material in thermal protection.

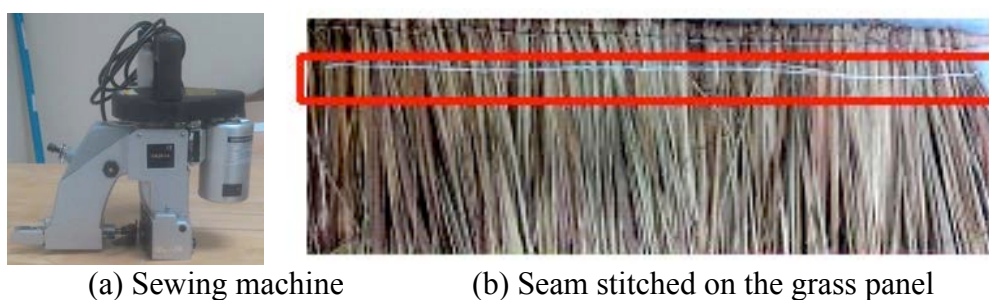

**Figure 1.** Vetiver roofing.

Today, the demand of vetiver roof in the house building and decorating business is very high especially hotel and restaurant decoration. However, all the vetiver roof producing are the handicraft activities. It found that there was a limitation in labor skill because there are complicated and time consumed work. The concisely process of vetiver roofing material manufacturing by operator was shown in Fig. 2. It has an attempt to design the semi-automatic machine or equipment to assist the vetiver roof manufacture. An assisted equipment prototype by Saisang K., Treamnuk K. and Treamnuk T. in vetiver roofing material production was reported that it is a folding plate to fold a grass sheet (prepared by sorting a stalk grass on the plate to a grass sheet layer form) with a wood rod. The grass bunch lacing by hand was replaced by sewing the grass sheet by a needle and mechanism. The prototype can help an operator to reduce the fatigue in working and able to increase the productivity. It can reduce a 3 minute/vetiver panel in producing time. But, the sewing by needle mechanism also takes a long time and has the tangled thread problem so, the electric sewing machine GK26-1A is replaced use in this study (Fig. 3).



**Figure 2.** The process of vetiver roofing material manufacturing



**Figure 3.** Sewing machine and its seam stitched

For the development of the vetiver roofing making machine, Ján Vavro, Jr., Ján Vavro, Petra Kováčiková and Radka Bezdedová reported the using of SolidWorks in motion study in kinetic and dynamic of continuous mechanism. The using results are significant reliability and it is an effective method to monitor all kinetic parameters of mechanism and can also identify loads for any power drive in the system. Therefore, it is effective way to use the motion studies function from SolidWorks software to determine the limitation of movement in terms of kinematics and specify their necessary powertrain too.

This research proposes to determine the limitation of mechanism and powertrain of the vetiver roofing making machine. The intention of this article is to apply this results study with the prototype machine that will be fabricate in the next project research.

## Mechanism and Powertrain studies

### 1) Mechanism and Powertrain Studies

#### 1.1) Prototype and operation

The components and concept operation of machine prototype (Fig. 4) was described as a following.

1. The operation begins by operator feed the vetiver grass into machine tray (No. 6 in Fig. 4 and Fig. 5a) and sort it in form of grass sheet layer. After that, the operator inserts a wood rod frame on the vetiver grass sheet at position (No. 7 in Fig. 4 and Fig. 5b).

2. The wood rod frame gripping mechanism (No. 3 in Fig. 4 and Fig. 5c) gripes the rod standing on the grass sheet by nails (Fig. 5b). Then, grass sheet folding mechanism (No. 1 in Fig. 4) folds and enfolds the wood rod frame by the grass sheet layer (Fig. 5d – 5e).

3. The grass sheet pressing mechanism (No. 2 in Fig. 4) is sliding down to press the folded grass sheet (Fig. 5e). After that, the tray just slides and carry the grass sheet feed into the electric sewing machine (No. 4 in Fig. 4) by the electric motor (No. 5 in Fig. 4)

4. The sewing machine just stitches the grass sheet layers seamed together (Fig. 5f). Then, the process is finished.

5. After that, all mechanism will move back to the begin position and wait for next operation starting.

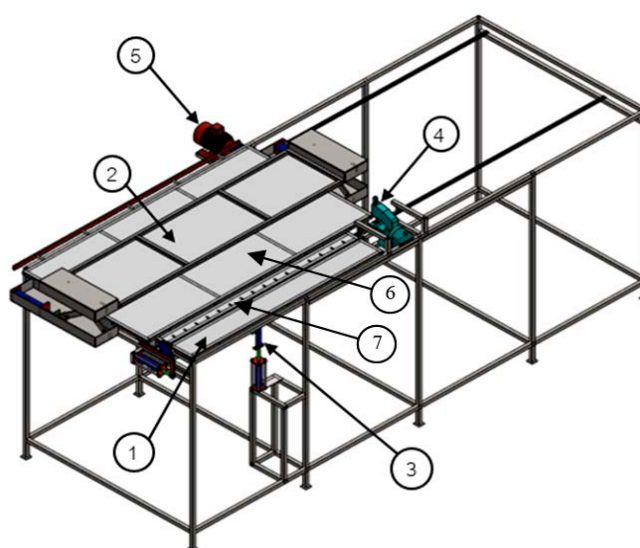

**Figure 4.** Component of prototype machine

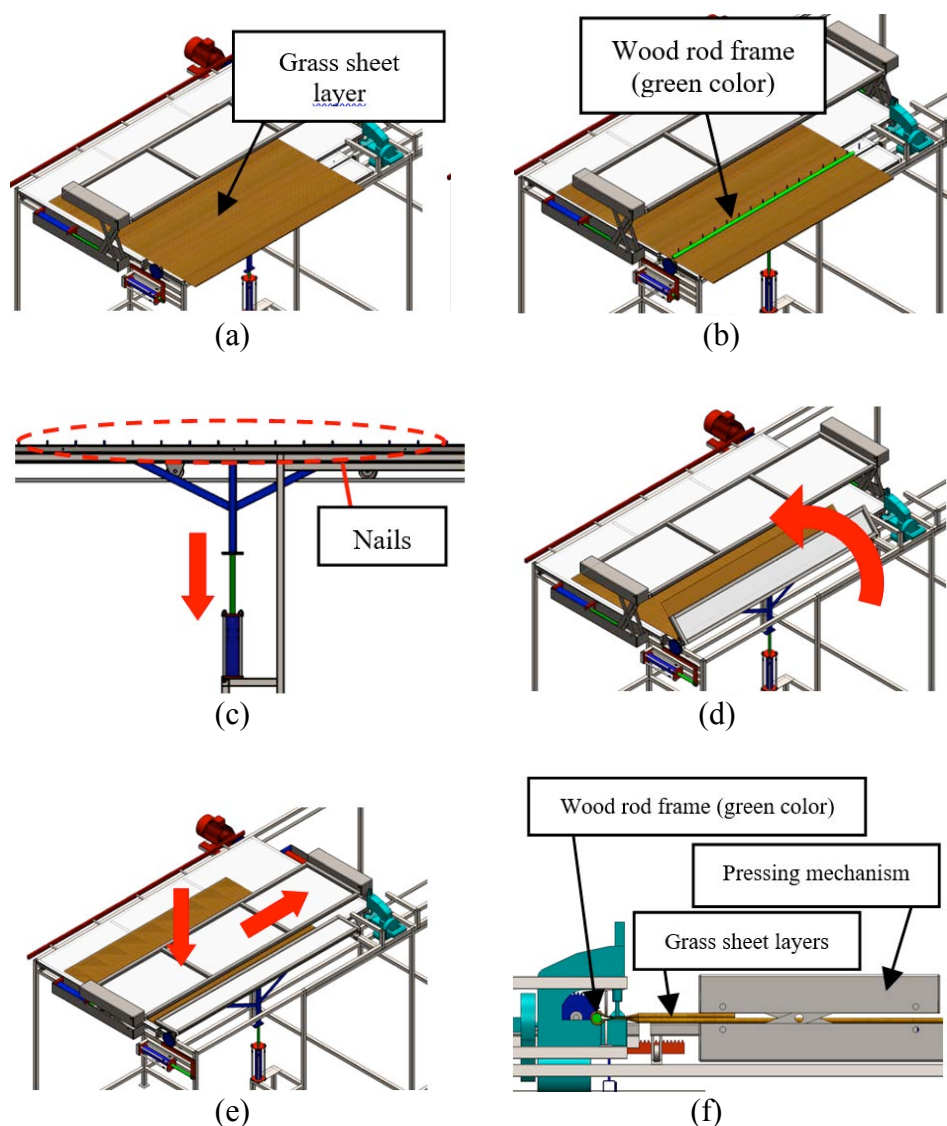

**Figure 5.** The operation of prototype machine

### 1.2) Mechanism

The motion and the power drive of mechanisms are:

1. Grass sheet folding mechanism was driven by pneumatic cylinder. It transforms a rectilinear motion to rotation motion by rack and pinion mechanism (Fig. 6a).

2. Grass sheet pressing mechanism was driven by the pneumatic cylinder. It transforms a horizontal sliding motion to vertical lifting motion by x-lift mechanism (Fig. 6b)

3. Wood rod frame gripping mechanism was driven by pneumatic cylinder to lift the nails bar up and lay down to gripe the wood rod (Fig. 5c)

4. Sewing mechanism, this mechanism uses an electric sewing machine model GK26-1A.

5. Grass sheet feeding mechanism was driven by electric motor and the rectilinear motion of the machine tray was transmitted thru pinion and rack mechanism (Fig. 6c).

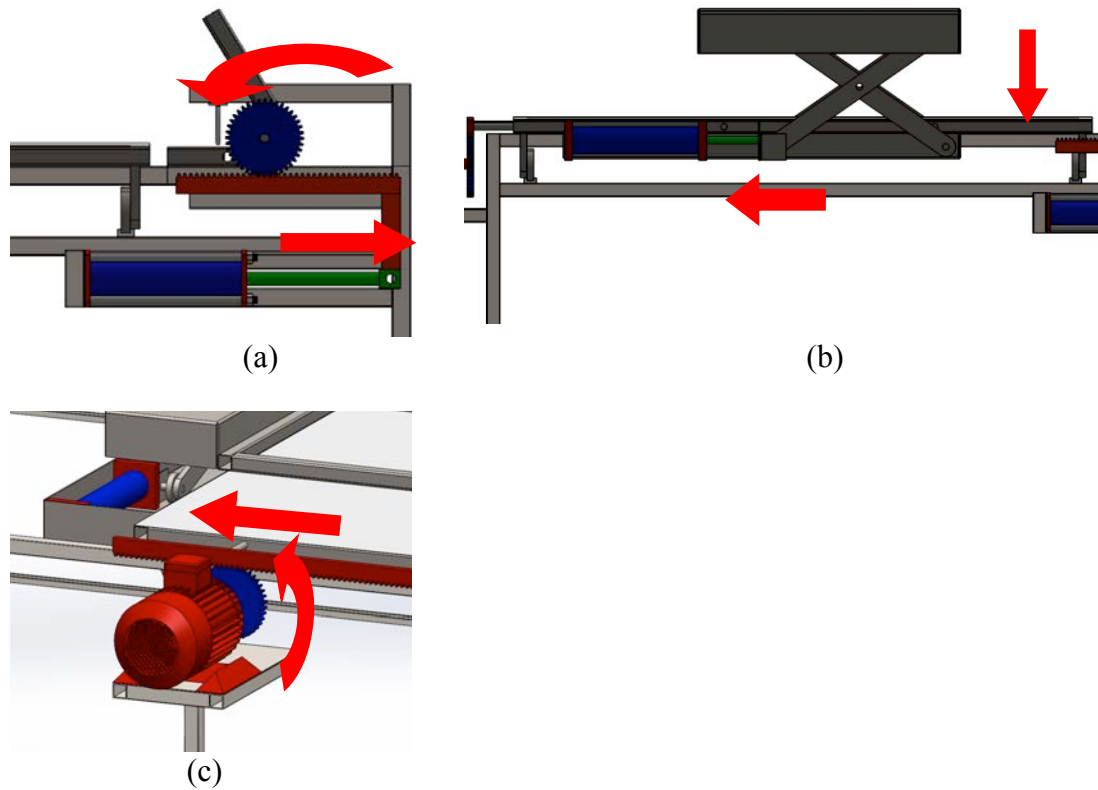

**Figure 6.** (a) Grass sheet folding mechanism (b) Grass sheet pressing mechanism and (c) Grass sheet feeding mechanism

1.3) Sequence of operation.

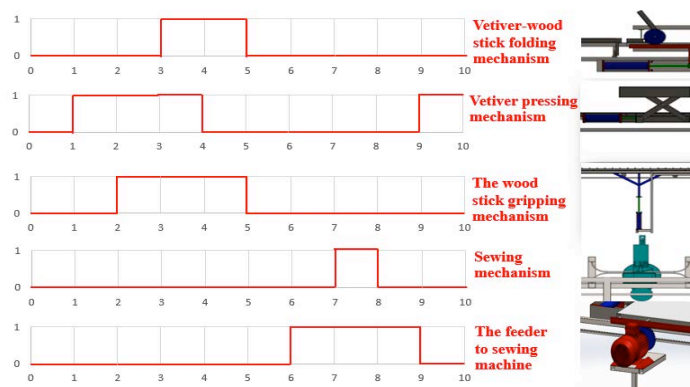

**Figure 7.** Sequence operation of the prototype machine

The components mechanism and sequence operation were described by the diagram in Fig. 7 where “0” and “1” on vertical axis are rest position and active position of an actuator respectively. Position “1” on horizontal axis is the start point of an operation and position “10” is the finish point. For the sequent order working, the feedback

signals in each driver unit were used for control an operation of actuators and motor with Programmable Logic Control (PLC) module.

## 2) Mechanism and Powertrain Studies

### 2.1) Inertia force

The inertia force and inertia torque in mechanism was affected by an acceleration of machine motion described by (1) and (2) for rectilinear and rotating motion respectively.

$$F_o = ma \quad (1)$$

Where  $F_o$  is Inertia force (N)  
 $m$  is Mass of mechanism (kg)  
 $a$  is Acceleration ( $m/s^2$ )

$$T_o = I\alpha \quad (2)$$

Where  $T_o$  is Inertia torque (N·m)  
 $I$  is Inertia of mechanism ( $kg \cdot m^2$ )  
 $\alpha$  is Angular acceleration ( $rad/s^2$ )

### 2.2) X lift (Scissor lift)

X-lift or jaw mechanism is a lifting mechanism. The applied force on the leg when system is balance shown in (3).

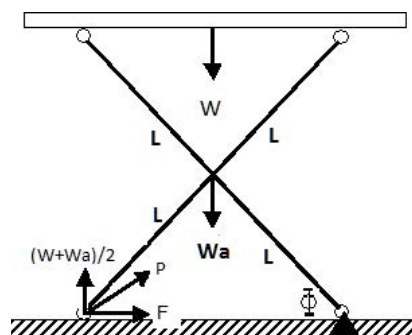

**Figure 8.** X-lift mechanism

$$F = \frac{(W + W_a) / 2}{\tan \Phi} \quad (3)$$

Where  $F$  is Applied force used (N)  
 $W$  is Load weight (N)  
 $W_a$  is Total arm frame weight (N)  
 $\phi$  is Angle between frame and arm (degree)

### 2.3) Electric motor power

A required motor power can determine by (4)

$$P = T\omega \quad (4)$$

Where P is Power of motor (W)

T is Torque (N·m)

$\omega$  is Angular velocity (rad/s)

#### 2.4) Pneumatic supply system

When supply the compressed air to a system, the force (F in N) required at the actuator can determine by the pressure of system (P in Pa) and the area of the piston (A in m<sup>2</sup>) by (5).

$$A = \frac{F}{P} \quad (5)$$

The air flow rate Q in liter/min can calculate by the displacement volume of cylinder (V in m<sup>3</sup>) divided by the time (t in minute). The formula for flow rate is (6) [5].

$$Q = \frac{V}{t} \quad (6)$$

And displacement volume is the product of the piston area and the stroke (L in m) (7).

$$V = AL \quad (7)$$

#### 2.5) Motion studies in SolidWorks

1. Mechanical properties of vetiver grass was tested by use the vetiver grass specimen under the Universal Testing Machine (UTM) for evaluate bending force (Fig. 9). This bending force was used to calculate the necessary torque for grass sheet folding mechanism.

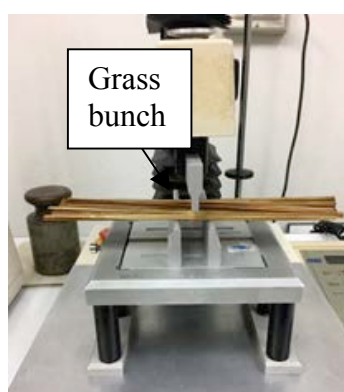

(a) Bending test on UTM

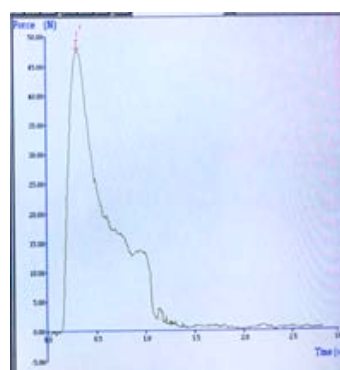

(b) Bending force graph

**Figure 9.** Bending test of vetiver bunch

2. CAD files of the prototype (SLDASM file) designed from SolidWorks software was analyzed by the motion studies function to determine the magnitude of force of the driving element in each mechanism. The external force, gravity, material properties of every elements and limitation of element movement were specified in the function for calculation. This method take a less time in processing and provides



an appropriate calculation results that are equal to hand calculation with (1) to (3) for the value of interesting variables.

3. The calculated force magnitude results in each driver element from program were used to evaluate the limitation of powertrain in the machine by (4) to (7).

## Results and Discussion

Based on the motion studies from SolidWorks when the range and time of motion is specified, the magnitude of force to overcome the inertia and gravity of motion are as follows.

### (1) Vetiver grass sheet folding mechanism

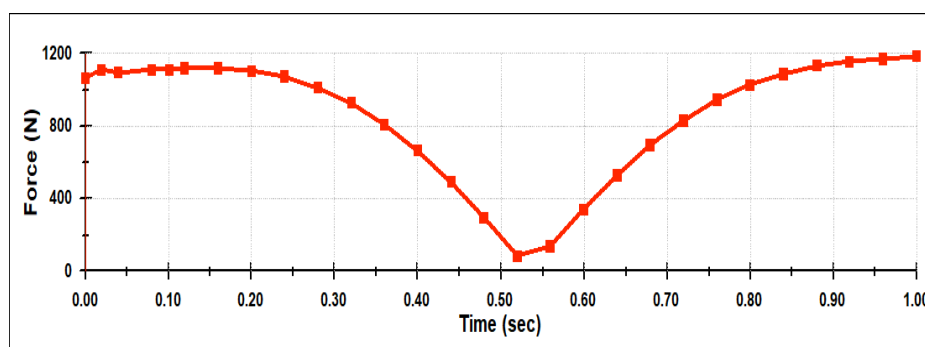

**Figure 10.** Relation between force change and time of grass sheet folding mechanism

From Fig. 10, the range of movement in this mechanism is 156 mm equaled to stroke of pneumatic power drive piston. At the motion times 1 s, the maximum force required for this mechanism was 1,200 N. At the time 0.55 s, an applied force is smallest because in this time the folding mechanism is in the perpendicular position with the line of piston motion and gives shortly radius of moment so, the moment is smallest too. For the air supply pressure 6 bars the necessary bore size of power drive pneumatic for this mechanism are 63 mm in diameter and it need an air supply rate 28.08 liters/min.

### (2) Grass sheet pressing mechanism

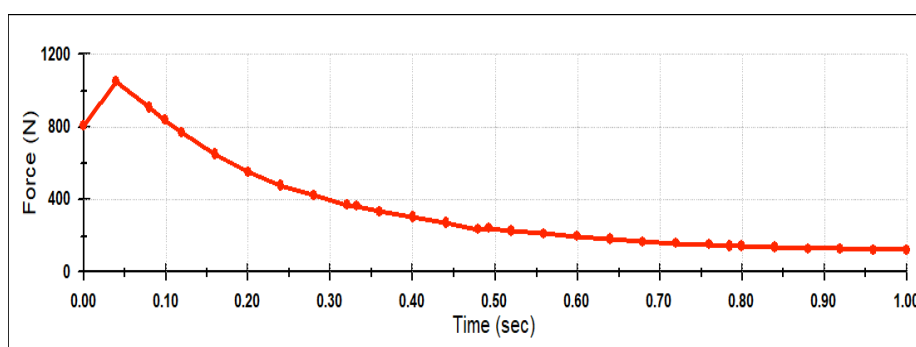

**Figure 11.** Relation between force change and time of grass pressing mechanism.

From Fig. 11, the result found that the maximum force required to lifting this mechanism is 1,100 N, and it have a decreasing trend when the time increases. The necessary bore side of pneumatic power drive is 40 mm in diameter and the supply air should be 15.06 liters/min when their supplied pressure is 6 bars.

### (3) The wood stick gripping mechanism

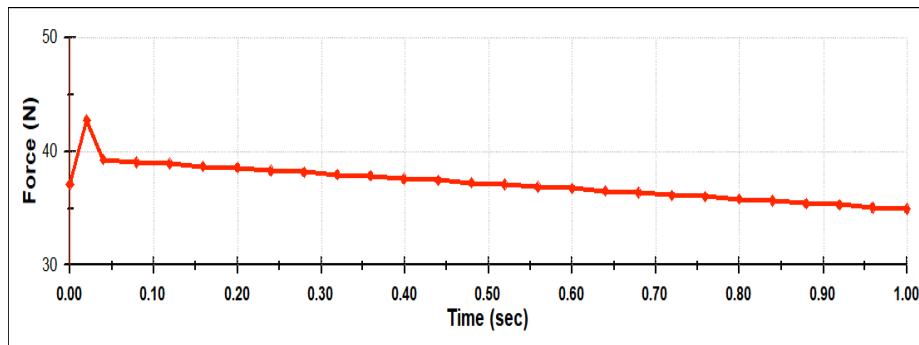

**Figure 12.** Relation between force change and time of the wood rod frame gripping mechanism.

In Fig. 12, the pneumatic a piston displacement is 100 mm and the moving time is 1 s in movement of the mechanism. It found that the maximum force required for this mechanism is 43 N at time 0.025 s. After that, the apply force will change with a constant rate of decreasing. The diameter of required pneumatic piston should be 12 mm with the air supply of 0.66 liters /min at 6 bars of air pressure.

### (4) The grass sheet feeder mechanism

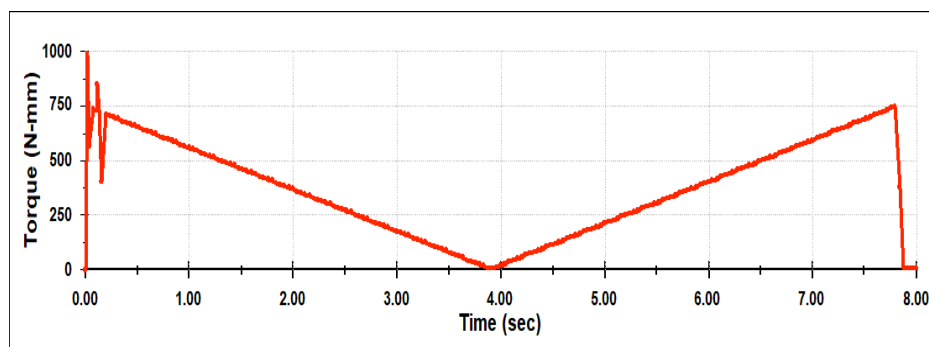

**Figure 13.** Torque changes by the time of feeder mechanism motion.

From Fig. 13, the driver pinion was specified 1,718.8 degrees of angular distance movement (equal to required 1.8 meters in rectilinear range of vetiver panel that will feed to the sewing machine). The pinion just rotates at 1,718.8 degrees in 7.82 s time (equal to Angular velocity 3.83 rad/s). Found that the maximum torque required for drive the pinion in this mechanism is 1,000 N • mm (1 N • m). On the first half of 8.00 s moving time, the pinion just starts rotating and need a maximum torque to turn all mechanism. After that, the last 4 s of moving time the system needs a maximum torque again to stop the rotating and rest in finally. The motor power calculation show that the system required a 50 Watts of power.

## **Conclusions**

The using of SolidWorks 2016 Software to design and determine the limitation of mechanisms and powertrain by the Motion Studies function found that the designed machine required a 6 bars of air supply pressure and could has 5 mainly components as following (1) Grass sheet folding mechanism driven by the 63 mm diameter of pneumatic cylinder with the 28.08 liters/min air supply. (2) Grass sheet pressing mechanism powered by a couple of 40 mm diameter of pneumatic cylinder with the air supply 15.06 liters/min. (3) The wood rod frame griping mechanism driven by the 12 mm diameter of pneumatic cylinder with the air supply 0.66 liters/min. (4) The grass sheet feeding mechanism for the sewing process used the 50 Watts electric gear motor and (5) Electric sewing machine model GK26-1A to seam the grass sheet with the wood rod frame.

## **Acknowledgement**

The authors wish to acknowledge the Bio-System Engineering and Technology Laboratory, Suranaree University of Technology for the research support.

## References

Saisang K., Treamnuk K. & Treamnuk T. (2018). Conceptual Design Study of Semi-automatic Machine for the Production of Vetiver Grass Roofing. Presented at the 7<sup>th</sup> PHAYAO Research Conference, Phayao, Thailand. January 25-26, 2018.

Ján Vavro, Jr., Ján Vavro, Petra Kováčiková & Radka Bezdědová. (2017). Kinematic and dynamic analysis of planar mechanisms by means of the SolidWorks software. *Procedia Engineering*, 177, 476 – 481.

Mabie H. H. & Reinholtz C. F. (1986). *Mechanisms and Dynamics of Machinery*. (4th ed.). United State of America: John Wiley & Sons Inc.

James A. Sullivan. (1998). *Fluid Power Theory and Applications*. (4th ed). Upper Saddle River, New Jersey: Prentice-Hall Inc.

**Contact email:** krawee@sut.ac.th, tawarat@sut.ac.th,  
narm.saisang@gmail.com.

## ***Influence of Intake Air Temperature on Performance of Small Gasoline Engine***

Tawarat Treeamnuk, Suranaree University of Technology, Thailand  
Krawee Treeamnuk, Suranaree University of Technology, Thailand  
Sakkarin Papakae, Suranaree University of Technology, Thailand

The Asian Conference on Sustainability, Energy & the Environment 2018  
Official Conference Proceedings

### **Abstract**

This research study was to investigate the influence of intake air temperature on the performance of a multi-propose small gasoline engine. The four-strokes gasoline engine with single-cylinder of 208 cm<sup>3</sup> was tested at speed of 1,500-4,000 RPM. The intake air temperature was prepared in case of 1) warm temperature that was like the air around the engine at 50°C - 55°C and room humidity 2) low temperature, warm air was cooled by using evaporative cooling pad system (ECP) with the room temperature water and 3) very low temperature, warm air was cooled by using the ECP system with 0.5°C of cool water. The engine performance was tested on the water break dynamometer to determine torque, speed, fuel consumption, air induction rate. The result shown that the reducing air temperature before taking into the engine by ECP system influences on the increasing of density, relative humidity and pressure of the intake air. The low temperature of intake air provides an engine torque and power increasing. The power increases 3.21% at 2,000 RPM of engine speed (use room temperature water) and 7.76% at 3,500 RPM (use cool water) and the specific fuel consumption reduces 7.04% at 3,500 RPM. The exhaust temperature and HC emissions are decreased when compare to the warm intake air.

Keywords: Evaporative cooling, Intake air temperature, Engine testing, Engine performance

**iafor**

The International Academic Forum  
[www.iafor.org](http://www.iafor.org)

## Introduction

Small multi propose gasoline engine is a world wide favor useful engine. Because this engine is not expensive, easy to control the speed, installation, power transmission, and have an accuracy control system. In Thailand, small multi propose engines are used in water pump, electricity generator, power for agricultural machinery such as two wheels tractor, mowers, fertilizer and chemicals sprayer, chopper machine and tools for cultivation, etc. Although this engine is highly popular, but it has a problem in operation because it cannot provide the high theoretical performance in practical applications. Especially the stationary engine, the air around the engine accumulates heat from the engine cooling system and changes to be the warm air at 50°C - 55°C due to the engine is running. At this temperature, the air is low pressure than cool air and has low density too. Unavoidably, this warm air will be taking into the engine and effects the engine thermal efficiency to low value in finally. Therefore, the reducing of intake air temperature is important and can directly improves the engine performance without difficultly modify the engine components. The reducing of air temperature by water evaporative cooling is a simple method. Using free water surface on the wet porous pad (or Evaporative air-water cooling pad system, ECP) (Fig. 1), the warm air can flow pass and lose its heat to the water. At the same time, the heat that water was received in form of latent heat change the liquid phase of water to be a gas phase. After that, it mixed within the air and flow out from the system. So, this method must increase the humidity of air ever (Papakae *et al.*, 2017). At present, the ECP was most applied in an air conditioning system. Because it is a simple system, not complicated equipment, designed to be a compact and more ability to reduce air temperature down 15°C from room temperature. The low temperature air by this technique can increase 10.6% of overall air conditioning efficiency and decrease 11.4% of compressor power consumption (Martínez *et al.*, 2016).

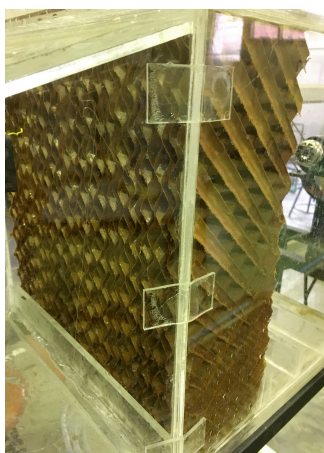

Figure 1: Evaporative cooling pad.

Many researchers are interested to study about the effect of air temperature on the engine operation. Sajovaara *et al.* (2015) reported that the reducing of air temperature before inducting to the engine can reduce the NOx emission and exhaust temperature of diesel engine, and the effect of steam or water filled into the gasoline engine is it can reduce fuel consumption by 6.44%, reduce NOx emissions by 40%, reduce HC 31.5% (Cesur *et al.*, 2013). The using of water on diesel engine had ability in exhaust smoke reduction (Sahin *et al.*, 2012).

From the advantages of ECP system and low temperature and moist air induct to the engine on performance and emissions, this research aims to study the influence of air that was reduced the temperature by ECP system on the intake air properties, performance and emission of the engine exhaust gas.

## **Materials and method**

### ***1) Test apparatus***

The test apparatus from TecQuipment model TD201 use the single cylinder 4 strokes gasoline engine (Fig. 3) that had Bore size 70 mm, Stroke/Crank radius (mm) 54/27, Engine capacity 208 cm<sup>3</sup>, Compression ratio 8.5 and Power 5.2 kW. The schematic diagram of this experiment was shown in Fig. 2. The engine shaft of test apparatus was connected to the shaft of the water break dynamometer. The intake air was pumping by the engine cylinder and flow through the evaporator (or ECP) to the engine cylinder. In this system, the intake air is not the warm air around the engine like an actual engine operation because the cooling system (evaporator) is adding and the air inlet duct is far from the engine (Fig.3). For solving this problem, the air heater was installed in the test apparatus to create and keep the warm intake air for the engine similar an actual engine operation.

### ***2) Evaporative Cooling Pad (ECP)***

The ECP model 7090 with a dimension of 30 x 27 cm<sup>2</sup> in W x H and 100 mm of thickness was modified to the intake air cooling system (Fig. 3). The water in the cooling system was flow through the pad and circulated between pad and water tank by electric pump.

### ***3) Experiment***

An intake air temperature was prepared in case of 1) warm intake air similar to the air around the engine at 50°C - 55°C and room humidity by use the air heater (not use the water in this case) 2) low temperature intake air by the use of evaporative cooling pad system (ECP) with the room temperature water and 3) very low temperature intake air by using the ECP system with cool water temperature of 0.5°C. In the testing, the butterfly valve of the engine is wide open and breaks the engine with a constant load for investigating torque (N.m), fuel consumption (ml), air induction rate (kg/s) and emission in term of exhaust temperature (°C) and HC (ppm) at the engine speed of 1,500, 2,000, 2,500, 3,000, 3,500 and 4,000 RPM respectively.

For the measurement, engine torque was measured by S-Type load cell. Air temperature and humidity were measured via a dry and wet bulb temperature of air with thermocouple type K. The engine exhaust emissions were analyzed by an automotive emissions analyzer (HORIBA Model MEXA-584L).

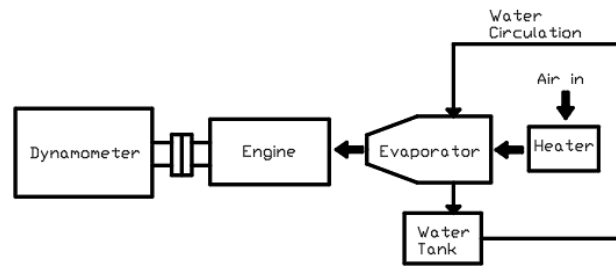

Figure 2: Schematic diagram of experiment system.

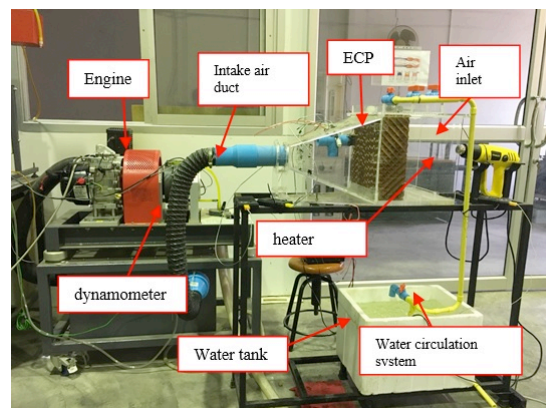

Figure 3: Equipment in the experimental system.

The engine performance was evaluated by (1) and (2) (Heywood, 1998)

$$W_b = 2\pi NT$$

(1)

Where  $W_b$  is engine break power (kW)

$N$  is engine speed (rev/s)

$T$  is engine torque (N.m)

$$b_{sfc} = \frac{\dot{m}_f}{W_b}$$

(2)

Where  $b_{sfc}$  is break specific fuel consumption (g/kW.hr)

$\dot{m}_f$  is rate of fuel consumption (kg/s)



## Result and discussion

Table 1. Properties of intake air

Intake air	Temp. (°C)		Density (kg/m <sup>3</sup> )	Absolute humidity (kg <sub>water</sub> /kg <sub>air</sub> )	RH (%)
	Dry bulb	Wet bulb			
Warm temp.	52.8	34.3	1.0390	0.02705	29.8
Low temp.	31.1	26.6	1.1254	0.02098	75.2
Very Low temp.	21.9	16.8	1.1788	0.00985	60.1

The experiment results showed that the reducing of air temperature before taking into the engine with the ECP system effects on the air properties. From table 1. the inlet supplied air temperature to the test apparatus is equals in every experiment and constantly controlled the air temperature at 52.8°C (warm air) by the heater. On the first row of table 1. the warm air is not cooled by the ECP and directly intake to the engine with the high temperature, so the density of air is lowest. After the warm air is cooled by ECP (the 1<sup>st</sup> and 3<sup>rd</sup> rows of table 1.), the using of water at room temperature (around 23.7°C) in ECP system can reduces the temperature from 52.8°C to 31.1°C and can increases the air density to 1.1254 kg/m<sup>3</sup>. This temperature reducing trend is similar to the case of very low temperature intake air when using the cool water at 0.5°C in ECP system. In term of moisture, the relative humidity is increasing when the intake air was cooled by ECP. In fact, the mass of water in air is not increase, on the other hand it is decrease because the dew temperature of the inlet air (warm air) is higher than the ECP temperature. As a result, a water in warm air is condensed at ECP and be the cool and dry intake air in finally.

The air density and temperature were used to calculated by Gas law (Cengel, 2004) to determine the intake air pressure and the relation between the pressure and engine speed was shown in Fig. 4.

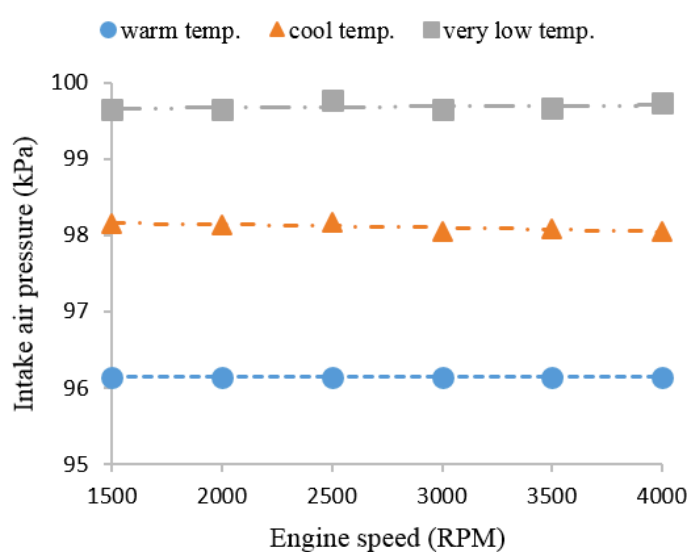

Figure 4: Relation between intake air pressure and engine speed.

From Fig. 4, the intake air pressure is almost unchanged when the engine speed increase. The effect of intake air temperature reducing is increased the intake air pressure because of the increasing of air density. At the very low temperature of intake air, the pressure is highest and increases closely to 100 kPa.

For the measured torque that was produced by the engine, the result found the reducing of intake air temperature can increase torque in every engine speed. The magnitude of torque is increasing when the intake air temperature is more decrease and the maximum torque occur at 2,500 RPM engine speed. Because the higher air mass (by the increasing of air density) and pressure was induced to the engine, the maximum pressure in cylinder after power stroke is rising and create the higher torque in finally. The torque increases 3.21% at 2,000 RPM of engine speed (use water 23.7°C in ECP) and 7.76% at 3,500 RPM (use water 0.5°C in ECP) when compare to the warm intake air. This effect was shown in Fig. 5.

In term of the engine power from Fig. 6, when the engine speed increased, the power of the engine also increased too. Similar to the trends of increased torque when intake air temperature is reduced, the engine power is continuously increasing because it is the multiplied result of torque and engine speed, although the last engine speed the value of torque is decreased but the influence of speed in (1) is more effect than the value of torque.

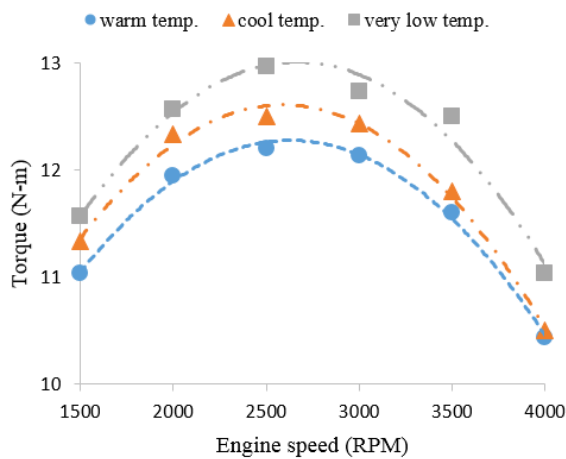

Figure 5: Relation between torque and engine speed.

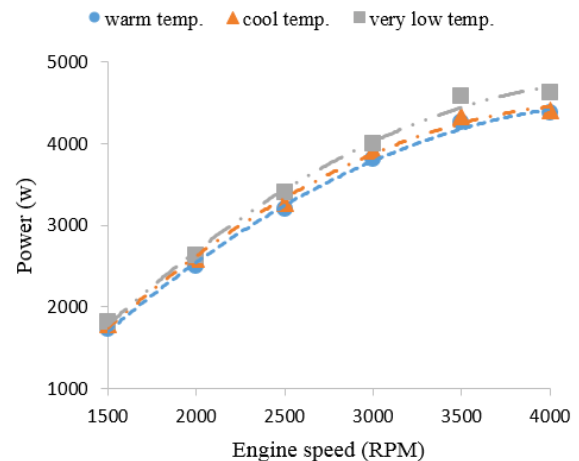

Figure 6: Relation between power and engine speed.

The fuel/air ratio of the cool intake air is reduced (Fig. 7) by the influence of air temperature reducing because the rate of fuel consumption is almost constant in any intake air temperature, but the air consumption has a rising trend when its temperature is decrease.

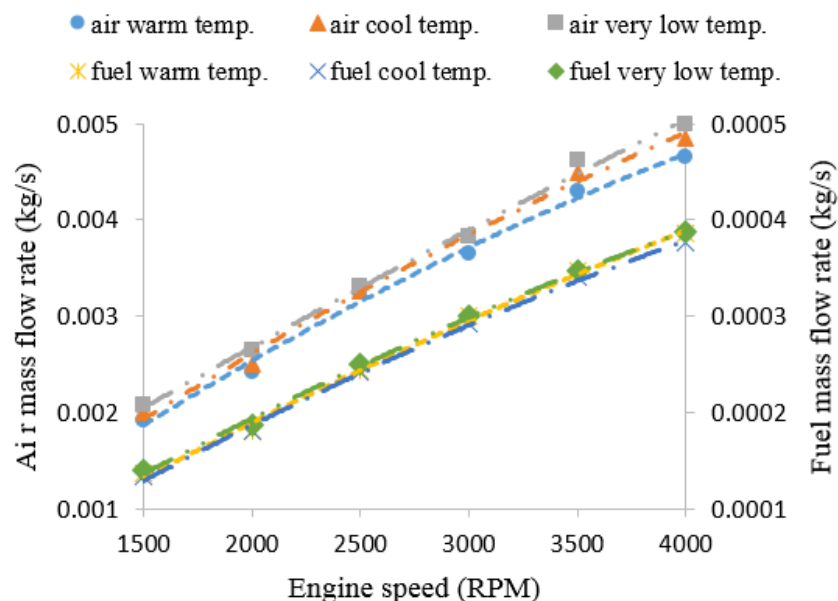

Figure 7: Relation between air (left axis) - fuel (right axis) consumption and engine speed.

The relation between the  $b_{sfc}$  and speed of the engine is presented in Fig. 8, the  $b_{sfc}$  was decreased when engine speed increase from 1,500 to 2,500 RPM and after that tend to increase when the engine speed is increased of every intake air temperature. Considering on intake air temperature found that when the intake air temperature is reduced, the  $b_{sfc}$  of the engine was decreased because the power of engine was clearly increased (fig.6) while the fuel consumption was slightly increased (fig.7). The  $b_{sfc}$  of the engine was decreased 5.54% at 1,500 RPM of engine speed (use water 23.7°C in ECP) and 7.04% at 3,500 RPM (use water 0.5°C in ECP) when compare to the warm temperature intake air.

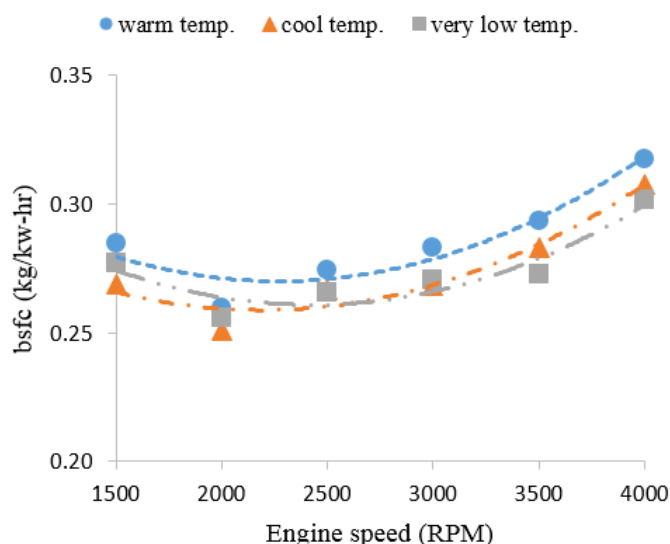

Figure 8: Relation between break specific fuel consumption ( $b_{sfc}$ ) and engine speed.

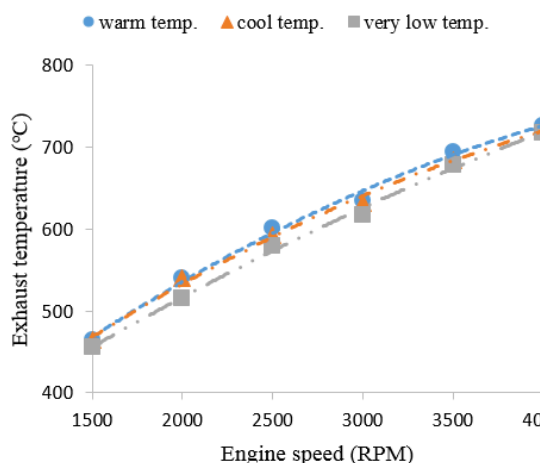

Figure 9: Relation between exhaust gas temperature and engine speed.

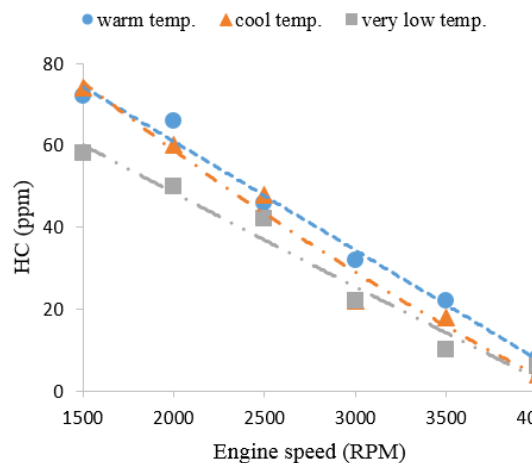

Figure 10: Relation between HC emission and engine speed.

Fig. 9 is present the relation between exhaust gas temperature and engine speed. When the engine speed increases the exhaust gas temperature from the engine also increased too. The very low temperature intake air was produced the lowest exhaust gas temperature when compare with the warm and low temperature intake air because the intake air temperature to the engine is lowest and when this air was finished the combustion, the exhaust gas in cylinder is not also heating over. Considering on HC emission found that the HC-emission of the engine was decreased when the engine speed increased (Fig. 10) and the reducing of intake air temperature affect to the decrease of HC emission because the rising of intake air mass in the engine cylinder help the combustion completely. The HC emission decrease 31.25% at 3,000 RPM of engine speed (use water 23.7°C in ECP) and 54.55% at 3,500 RPM (use water 0.5°C in ECP) when compare to the warm intake air.

## Conclusions

The reducing of intake air temperature by ECP system affect to the increasing of density, relative humidity and pressure of the intake air to the engine. The lower temperature of intake air affect to the engine power increases 3.21% at 2,000 RPM (use water 23.7°C in ECP) and 7.76% at 3,500 RPM (use water 0.5°C in ECP), the break specific fuel consumption of the engine decreases 5.54% at 1,500 RPM (use water 23.7°C in ECP) and 7.04% at 3,500 RPM (use water 0.5°C in ECP), the exhaust gas temperature is decreased and the HC emissions decreased 31.25% at 3,000 RPM (use water 23.7°C in ECP) and 54.55% at 3,500 RPM (use water 0.5°C in ECP) when compare with the warm intake air.

## Acknowledgement

The authors wish to acknowledge the Biosystem Engineering and Technology Research Unit, Suranaree University of Technology for the research support.

## References

- Cengel, Y. A. (2004). *Thermodynamics an Engineer Approach*. New York city: McGraw-Hill Science.
- Cesur, I., Parlak, A., Ayhan, V., Boru, B., & Gonca, G. (2013). The effects of electronic controlled steam injection on spark ignition engine. *Applied Thermal Engineering*, 55, 61-68.
- Heywood, J. B. (1998). *Internal combustion engine fundamentals*. Singapore: McGraw-Hill.
- Martínez, P., Ruiz, J., Cutilas, C. G., Martínez, P. J., Kaiser, A. S., & Lucas, M. (2016). Experimental study on energy performance of a split air-conditioner by using variable thickness evaporative cooling pads coupled to the condenser. *Applied Thermal Engineering*, 105, 1041-1050.
- Papakae, S., Nuekawai, W., Boonngern, K., Siriwatcharachaikun, R., Treeamnuk, K., & Treeamnuk, T. (2017). Numerical analysis of Thermodynamics Performance of Gasoline Engine. Presented at the 2<sup>nd</sup> National Conference on Informatics, Agriculture, Management, Business Administration, Engineering, Sciences and Technology (IAMBEST 2017), Chumphon, Thailand. 31 May-1 June 2017.
- Sahin, Z., Tuti, M., & Durgun, O. (2012). Experimental Investigation of the effects of water adding to the intake air on the engine performance and exhaust emission in a DI automotive diesel engine. *Fuel*, 115, 884-895.
- Sajovaara, T., Larmi, M., & Vuorinen, V. (2015). Effect of charge air temperature on E85 dual-fuel diesel combustion. *Fuel*, 153, 6-12.
- Contact email:** tawarat@sut.ac.th, krawee@sut.ac.th, sakkarinpapakae@hotmail.com



## *Kala Cotton: A Sustainable Alternative*

Banhi Jha, National Institute of Fashion Technology, India

The Asian Conference on Sustainability, Energy & the Environment 2018  
Official Conference Proceedings

### **Abstract**

Further to the Brundtland Report, Our Common Future (1987) this paper extends the model of sustainable practices of ‘interconnecting people, processes and environment’ (Hethorn and Ulasewicz 2008) to the cotton-growing farmer community and users of cotton among organizations and Indian designers. Presently, 96% of India's cotton cultivation is under Bt (*Bacillus thuringiensis*) cotton crops, the first genetically modified crop to be approved for cultivation in India in 2002. While introduction of Bt cotton led to a dramatic increase in production across cotton producing states, there have also been controversies regarding allegations that it has spurred farmer suicides in the country, thereby pointing to the unsustainability of these genetically modified seeds. The greatest sustainability challenges for cotton cultivation are to reduce pesticides, fertilizers and water use while promoting better working conditions and financial returns for farmers. Organic cotton cultivation is a system that does not use synthetic pesticides, fertilizers, growth regulators or defoliants. Kala cotton is an indigenous, organic, rain-fed crop growing in eastern Kutch, Gujarat. This species of cotton offers obvious benefits including healthier soil quality and place less demand on the scarce water resources. In order to explore the possibilities of Kala cotton, some non-governments organizations (NGOs) are engaging with farmers to research about the crop to facilitate collaborations with weavers. Some fashion designers, online crafts and even a large textile mill are using Kala cotton for fashion apparel. Through survey and interviews of a sustainable fashion designer and an NGO, this paper discusses the resurgence of Kala cotton.

Keywords: Kala cotton, farmers, weavers, sustainability

**iafor**

The International Academic Forum  
[www.iafor.org](http://www.iafor.org)

## Introduction

Further to the Brundtland Report, *Our Common Future* which emerged from the 1987 World Commission on Environment posited sustainability as a realisable condition through the convergence of environmental, social and economic action, professionals have the ability to design systems that link human wants and needs through the design process using sustainable and ecological materials (Esslinger, 2011). Victor Papanek (1971) urged design professionals to commit to a higher social responsibility by adopting a sustainable design approach to determine future environments that will not intensify the environmental crisis. Adding to the advancement of Papanek's (ibid.) theory to the implementation stage by McDonough & Braungart (2002), this paper extends the model of sustainable practices of 'interconnecting people, processes and environment' (Hethorn & Ulasewicz, 2008) to the community of farmers and weavers of the indigenous Kala cotton yarn, fabric and textile products by independent organizations and Indian designers.

Cotton (*Gossypium hirsutum*) is a *kharij*<sup>1</sup> crop grown for its cash and fibre-yielding value cultivated under rain and irrigated conditions. The total climatic water requirement of cotton is about 700-1000 mm, which depends on the time of sowing and varies according to genotype, region, soil and management by farmers (Bhaskar *et al*, 2005). Even though cotton is a natural fibre, the large amount of water required by this crop is a matter of concern, and therefore minimizing water usage is imperative for it to be sustainable. However, 99 percent of West African cotton is rain-fed as is a large proportion of Indian cotton (Fletcher, 2008). Cotton crops alone account for 24% of the total global use of pesticides (Quinn, 2010). The greatest sustainability challenge for cotton cultivation is the need to reduce pesticides, fertilizers and water use. Organic cotton cultivation eschews the use of chemical pesticides, fertilizers, growth regulators or defoliants (Fletcher, 2008) as natural methods are used to control pests and weeds. Organic production causes singular reduction in the toxicity profile of cotton to zero.

The focus of this paper is on *Kala* cotton -an indigenous cotton that grows almost exclusively in the Kutch<sup>2</sup> area of Bhuj district of Gujarat in India and the commercial opportunities emerging from the increasing use of this fibre as an example of a sustainable fibre-yarn-textile chain enabling sustainable livelihoods for farmers and weavers.

## Methodology

Based on a survey of the Kutch region, this paper adopts a triple-pronged approach to study the experiences of weavers of Kala cotton; the initiatives of Khamir – an organization for the promotion of traditional handicrafts and associated practices including the production and promotion of Kala cotton; and the endeavors of design professionals engaged in the use of Kala for the development of 100% organic textile products. The participant stakeholders' lived experiences are studied through participant observation and in-depth interviews to understand their motivation in using the indigenous Kala cotton for sustainable livelihoods.



## **Bt Cotton in India**

In the last decade, there has been considerable debate about the cotton problem<sup>3</sup> in general and controversy about Bt (*Bacillus thuringiensis*) cotton in particular. While cotton has been cultivated for about five thousand years, Bt cotton is a relatively recent development of a genetically modified (GM) transgenic cotton developed by the techniques of genetic engineering that has insect-repellant toxins particularly against several bollworm species. Gruere and Sengupta (2011) claim that with the development of global agricultural corporation Monsanto's GM cotton seeds, Bt cotton was the first such crop approved for cultivation in India in 2002. This increased the area of cotton cultivation to 6.2 million hectares in 2007 (The Hindu, 2007). The official acknowledgement of Bt cotton for having increased production notwithstanding, this strain of cotton is highly controversial in India. Critical examination of GM crops in some countries including Africa, China and India has led to the conclusion that their performance and impact has in fact, been 'highly variable, socio-economically differentiated and contingent on a range of agronomic, socio-economic and institutional factors' that have obstructed the formulation of evidence-based policy (Glover, 2010). The benefits of its adoption for small landowners and farmers remain questionable.

Among other allegations, Bt cotton has been held responsible for being the main reason for several cases of farmer suicides across different parts of India. This purported cause and effect phenomenon has been a highly controversial issue particularly in the cotton growing states of Madhya Pradesh, Maharashtra, Andhra Pradesh and Tamilnadu (Krishnakumar, 2005; Nadal, 2007; Sahai, 2005). While environmentalist and activist Vandana Shiva attributes the spate of suicides particularly among Bt cotton farmers to these transgenic seeds, other researchers have refuted the alleged relationship between the suicides and Bt cotton cultivation and have posited other plausible causes (Gruere *et al.* 2008; Gruere and Sengupta 2010, Shah 2012). In reference to the history of cotton farming in India, Prasad (1999) has analyzed the motivations for the disregard of *desi*<sup>4</sup> cotton species in spite of their sturdy and pest resistant nature and the reasons for their perceived 'inferior' status as compared to hybrid and American varieties, claiming the dependence of farmers on pesticide dealers and the increasing expenditure on irrigation as the other possible reasons for these suicides. Based on the Parliamentary Committee report on Bt crops in 2012, a ten year moratorium has been imposed terminating all ongoing trials of transgenic crops.

## **Kala Cotton**

Archeological evidence shows that the date of cotton samples found at Mohenjo Daro sites such as Dholavira can be dated between 3250 and 2750 BCE produced from a cotton plant closely related to *Gossypium Arboreum* type. The indigenous *Arboreum* and *Herbaceum* varieties have been the predominant strains of cotton grown in India. Kala cotton is not a recently developed strain of cotton crop but is in fact, an indigenous strain of rain-fed cotton also referred to as 'old world' cotton. It had been a part of India's cotton export trade to Britain during colonial rule in India until in the last sixty years, the cultivation and weaving of Kala cotton almost disappeared.

Kala means ‘black’ in most Indian languages, often leading to the misconception that Kala cotton is black in colour whereas it actually refers to the boll after extraction of the cotton fibre. Belonging to the *G. Herbaceum* type with seed type usually of V-797 and G. Cot. 21., it can be recognized by its main feature of short to medium staple length of 20-22 mm. Its boll type is either closed or semi-open which is plucked along with the calyx.

Kala cotton has distinctive characteristics:

- i. It is an indigenous strain of cotton. People of Kutch refer to this type as Rammol<sup>5</sup> as it is organic by default. The prime differentiator between the genetically pure Kala cotton and the genetically modified Bt cotton is that though varieties can be developed by ‘Pedigree and Back Cross breeding’ methods, modern genetic engineering procedures are avoided (Khamir, 2012).
- ii. Kala cotton is sturdy and durable even in the face of difficult land and weather conditions. It imposes less demand on the scarce water resources making it very water-efficient. Studies have shown that approximately 1400 litres of irrigated water are required to grow one kilogram of other types of cotton. Kala is completely rain-fed and grows easily even in the arid, drought-prone areas of Kutch where there is less than 40 cm of rainfall. Its drought tolerance is so high that it does not require supplementary irrigation.
- iii. Rain-fed cotton offers obvious benefits including healthier soil and less demand on the water infrastructure, although there are trade-offs. Being rain-fed, the Kala cotton plant receives sporadic water which causes its fibres to be of coarser quality.
- iv. Kala cotton is ecologically more benign than other varieties of cotton. For the most part, it is grown in Kutch as a rain-fed crop with chemical fertilizer and pesticide-free approach which leads to healthier soil quality and makes it organic by default. While Energy - whether electrical or diesel, required for raising and supplying water for irrigation, as well as for the manufacture and transportation of chemical fertilizers, there are side effects wherein greenhouse gases are produced, the environment, soil and water are poisoned (Khamir brochure). While irrigated cotton in Gujarat generates 0.63% of greenhouse gases, other rain-fed hybrids in Gujarat generate 0.58% while Kala cotton in Kutch generates 0.11%, testimony to the fact that Kala cotton production in Kutch is among the most energy-efficient and carbon neutral in the world (ibid).

### **Kala Cotton Initiative by Khamir**

A joint initiative of Kachchh Nav Nirman Abhiyan<sup>6</sup> and the Nehru Foundation for Development, Khamir at Kukma, Bhuj is an organization engaged in the support and sustenance of traditional handicrafts, practices and culture, community and local environments. It was established in 2005 with the prime objective of addressing the critical situation that emerged after the earthquake in 2001 that devastated Bhuj. Rebuilding the area brought industrialization and employment in mills but also adversely impacted cultural livelihoods. With the introduction of industrialized textile production that catered to the demands of the export market, traditional weaving practices and local partnerships disappeared as did the cultivation of Kala cotton. The number of weavers in Kutch

declined from over 2000 in the mid-1990s to only 600-700 at the time. Small-scale weavers faced a dual problem – they were unable to buy raw materials in bulk, nor could they adequately cater to changing market dynamics. To address the problems, it was deemed imperative to start a three-stage initiative including initial explorations, development of a local value chain and subsequent scaling up with timely financial and technical support. Collaboration with other organizations<sup>7</sup> was the key to the strategy.

For this purpose Khamir initiated the Kala Cotton Initiative in collaboration with Satvik<sup>8</sup> and Setu Resource and Support Centre for sustained support of indigenous cotton farming followed by handloom cotton weaving. The preservation of agricultural and artisan livelihoods in Kutch necessitated raw material that was grown in the vicinity, was environmentally benign and held value for community. Khamir leveraged the potential of Kala cotton which was found to adhere to these criteria that re-iterated local and cultural practices in a modern idiom. Textile experts were consulted to address the challenges of the conversion of short staple length fiber into yarn. The financial returns and cultural potential of this cotton was explained to the handloom weavers, some of whom were earlier mixing natural with manmade yarn. Weaving was a challenge necessitating changes in the loom configuration with differing yields and shafts. After prolonged experimentation with spinning and weaving, the first Kala cotton products were produced in 2010. The use of the original old world cotton to create fabric in an integrated chain was reminiscent of the legacy of spinning and weaving khadi<sup>9</sup> cloth and its conversion into clothing and accessories in pre-independent India, reinterpreted for the modern marketplace. In creating a multi-layered value chain for marginalized communities using local cotton and traditional skills, the Kala Cotton initiative by Khamir is an example of an integrated approach to indigenous cotton cultivation and textile production in tandem with local ecology by facilitating synergized linkages for sustainable livelihoods for marginalized communities of farmers, spinners, ginners and weavers that have, in turn, encouraged its continued cultivation and use.

### **Spinning**

Spinning of Kala cotton yarn is undertaken on hand-operated charkha<sup>10</sup> at the hand spinning unit has been established by a hand spinning group in Manjal village with about ten women spinners. In some units there is a simultaneous use of the semi-mechanized, solar energy powered *Ambar* Charkha that reduces the rigour and time required for hand spinning and also enables experimentation in blending of short-staple Kala cotton yarn with longer staple natural yarn. To retain the authenticity of Kala it was necessary to monitor and ensure that synthetic or long-staple cotton is not blended with it. Therefore extending the scope of village level spinning mills, the processes of ginning, carding and spinning of Kala cotton are also carried out at the Ramakrushna Spinning Mills at Kutch where three hundred kilos of single twenty count yarn are spun daily.

### **Weaving**

Khamir engages with weavers directly and provides them with yarn for production. The tangible outcome of its initiative in promoting indigenous cotton is that the scale has

increased from 300 kilos to 30,000 kilos with a turnover of 14 million rupees (~209,160 USD) in 2015. The human factor in terms of the number of people engaged with Kala and earning livelihood include farmers (24 families), spinners (10 families), dyers (2 families) and weavers (70 families). Farmers receive a premium price and are therefore encouraged to grow indigenous cotton. Higher wages and market support have also contributed to the increase in the number of weavers. Remuneration for weavers is eighty rupees per metre which generates monthly income of minimum 10,000 rupees (~150 USD). There has been sectoral increase in the remuneration for weaving in Kutch. The cumulative result is that the value chain which had deteriorated for several decades is exhibiting resurgence in Kala cotton.

S No	Particulars	2014-15	2015-16
1	Kala cotton fabric (metres)	64,13,334	1,03,74,840
2	Kala cotton yarn sale (rupees)	16,59,558	29,69,536
3	Retail sale (metres)	6,56,626	19,71,195
4	Wholesale (metres)	57,56,718	84,03,645
5	Kala cotton weavers	34	49
6	Amount of purchase from weavers (metres)	44,84,349	57,66,628
7	Average monthly payment to weavers (rupees)	10,000 to 12,000	14,000 to 15,000

Fig 1: Details of finance and sales of Kala cotton

Source: Khamir

Though statistics indicate relative annual increase in demand of Kala, a substantial increase in sales is required for its sustainability. Khamir's revivalist efforts are evident also in the Makhel pocket of Adesar in the east Kutch from where it purchases cotton from 160 out of approximately 4000 Kala cotton farmers of Kutch. Of the remaining approximately 700 weavers at Adesar, only around 60 of them use Kala cotton. The threat of inconsistent demand, plagiarism from the powerloom sector and substitution by cheap non-organic cotton are impediments to the revival of Kala cotton on a larger scale.

To increase the marketability of the products and to project these handmade, environment friendly, limited edition products in a niche category, brand 'Kala' was positioned as aspirational synonym for the urban designer markets. From 2010 onwards designer-entrepreneur Archana Shah of Bandhej has mentored the entire product development. The products made during pilot phase were marketed to various designers and boutique owners of varied demographic profiles, and the feedback was reviewed. The entire Kala cotton initiative was launched at the Khamir exhibition '*Retelling the stories of crafts of Kachchh*' at Chinmaya Mission Hall, New Delhi in December, 2011.

### The Vankar Community

In 2001, in the barren wetlands of the Rann of Kutch, an earthquake measuring 7.7 on the Richter scale with its epicentre 20 kilometres from Bhuj, devastated over a million people causing death and destruction to villages and towns of Anjar, Bhachau and Rapar

(Vasudev, 2017). The resilience of the local people was instrumental in starting projects to revive textiles and handicrafts in the region. The Bhujodi village which has been home to the *vankar* (weavers) reclaimed itself to emerge as a hub for handloom cotton and woollen textiles. Even fifty years earlier, farming and weaving were the only two professions of Bhujodi inhabitants, each carrying on for half the year. But due to inconsistencies in the onset of monsoon, farming became unreliable which led to the shift from farming to weaving for sustainable livelihoods.

Weaver families often claim kinship with each other; several members are recipients of national level awards<sup>11</sup>. Shamji Vankar Vishram is one of the six brothers who oversees Vankar Vishram Valji Weaving, a family based dyeing and weaving business. His brother Arjun bhai points out how the workspace is designed with due consideration of natural elements of the sun and wind so that there is minimum or no use of electricity. There are looms available for young aspirants who want to learn weaving as a profession or hobby, or even to augment their formal education. Along with contemporary designs, some of which are chemical-dyed or use synthetic wool, the focus is on traditional designs that have been passed down the generations of this family. Over the last twenty years, Shamji has developed a thriving enterprise for Indian and international clients with adequate work for over sixty weavers. His own journey as a master craftsman, entrepreneur and recipient of the UNESCO Seal of Excellence mirrors and chronicles that of his family, the Bhujodi village and the craft of handloom weaving.

Chaman Siju hails from eleven generations of weavers and is committed to redefining the textile lineage of his family. His father Premji Vankar has been a National Award winner in 2001 as are several other members of the family including his brothers, mother and sister-in-law. A graduate of Judy Frater's *Kala Raksha* (Preservation of Traditional Arts) *Vidhyalaya* (school) which is the first institute of design for traditional artisans, Chaman Siju's weaving skills were supplemented and enhanced by the development of a contemporary design aesthetic that drew from traditional tenets. Committed to promoting indigenous artisans, his work iterates the importance of using indigenous materials including Kala cotton for regular orders as well as its potential as a fashion fabric to uplift the artisans working with traditional handlooms. At Textiles India 2017 in Gandhinagar, Gujarat – a mega event which celebrated fabrics from various regions of India, Kala cotton received a boost when the Prime Minister wore a Kala cotton stole by Chaman Siju. He aspires to create a local museum to house a collection of authentic Kala cotton and heirloom textiles from Gujarat.

### **Kala Cotton And Fashion**

At the intersection of people, processes, and the environment, design professionals constitute an important component in the development of sustainable products. They are able to make decisions related to development processes and procedures that affect the final sustainability of a product (Hethorn & Ulasewicz, 2008). Understanding the perceived and lived experiences of design professionals may result in comprehensive descriptions that lead to a greater understanding of the essence of the phenomenon (Moustakas, 1994) of the development of 100 percent organic cotton textile

products. Alison Welsh, Head of Fashion Research, Manchester Metropolitan University collaborates with Shamji Vankar for her project 'Field to Fashion' in conjunction with Khamir to explore the possibility of creating awareness about Kala cotton in the global market and place it in a niche segment for its strength, durability and striking resemblance to linen, and the application of this fibre in developing denim fabric. In India, contrary to the assumption that there would be a lukewarm response to the short-staple yarn, some fashion labels known for their conscious and conscientious approach to material sourcing and production including *Bandhej* by Archana Shah, *Cell DSGN* by Shani Himanshu, *Maku Textiles* by Shantanu Das, *Anavila* by Anavila Mishra, *Deepika* by Deepika Govind, *AND* by Anita Dongre Design, *Urvashi Kaur* by Urvashi Kaur and others have showcased Kala cotton for its unique visual and textural qualities. London-based *Stitch* by Stitch sources Kala cotton for home furnishings. The certification of Kala cotton has given authenticity and value to the product range. Kala cotton is also in the process of registration as a trademark.

### **Conclusion**

The integrated endeavour of Khamir in supporting farmers and encouraging the *vankar* of the Bhujodi village of Kutch and fashion designers who have exhibited both professional and personal identification as well as commitment to sustainability through their role in the use of this indigenous cotton has resulted in an upsurge of consumer interest in Kala. Today there are 4000 small and marginal farmers based in 30 villages of Rapar and Bhachau blocks of Eastern Kutch and in the Patdi, Dasada and Mandal blocks of Surendranagar in Gujarat cultivating the around 15000 tons of cotton every season. The narrative of Kala cotton is relevant to academia and conscientious consumers as an example of the effectiveness of 'localism' (Fletcher 2008) by espousing the use of indigenous fibre grown within 150 miles. The impact of their initiatives has resulted in the revival of an erstwhile unsustainable cotton crop as a sustainable alternative to Bt cotton. The increased demand for authentic Kala cotton products tells the story of this indigenous cotton in a 'voice' which is authentic and sensitive to the ethos of the land.

### **Acknowledgements**

I would like to thank Juhi Pandey, Ghatit Laheru and Paresh Mangaliya of Khamir for their support and insight; Shamjibhai and Arjunbhai, Chamanbhai, Premji Vankar and Khengarbhai Vankar for sharing the history of Kala cotton and their own journeys.

## Notes

<sup>1</sup>Indian crops are classified into Kharif and Rabi, sown according to seasons. Kharif crops are sown and harvested between July - October at the onset of south-west monsoon.

<sup>2</sup> Also spelt Kachchh

<sup>3</sup>The 'cotton problem' related to the policy issues of the global cotton market received widespread coverage in the international media between 2002 and 2004 following the WTO General Council's decision on multilateral trade negotiations and cotton subsidies.

<sup>4</sup> Indigenous, local

<sup>5</sup>*Ram* refers to an Indian god and *mol* means crop

<sup>6</sup>Also referred to as Abhiyan, it is a collective of Kutch based development organizations governed by community initiatives

<sup>7</sup>Khamir collaborates with several organizations for mutual benefit. It shares common goals with Kachch Nav Nirman Abhiyan (KNNA) related to Kutch crafts which provides a common platform for their craft-related activities. The Khamir Campus was built through the initiative of the Nehru Foundation for Development (NFD) and KNNA for funding to build craft parks in earthquake-affected regions. It partners with Craftroots to collaborate on varied craft development projects. Kutch Mahila Vikas Sangathan (KMVS) helps to link groups of women garbage collectors to create a local supply chain for Khamir's Plastic Recycling Project.

Khamir is supported by All India Artisans and Craftworkers Welfare Association (AIACA) to improve health and safety conditions for Indian textile workers including the effluent treatment plant linked to Khamir's dyeing unit. The Friends of Women's World Banking is a premier financial institution that supports small scale entrepreneurs, particularly women as well as Khamir's Kala cotton initiative. Hunnarshala supports through seed grant and technical expertise. The Kandla unit of IFFCO helps Khamir with funds for artisan development, welfare activities, and promotion of craft products.

<sup>8</sup>Satvik is an association of organic farmers in Kutch

<sup>9</sup>Hand spun and hand woven fabric using natural cotton and silk yarn

<sup>10</sup>Indigenous spinning wheel

<sup>11</sup> Shilp Guru and National Awards presented to master craftspersons

## References

- Bhaskar, K.S.; Rao, M.R.K.; Mendhe, P.N.; and Suryavanshi, M.R.(2005) 'Micro Irrigation Management in Cotton' CICR Technical Bulletin NO: 31. Available at [http://www.cicr.org.in/pdf/micro\\_irrigation.pdf](http://www.cicr.org.in/pdf/micro_irrigation.pdf) [Accessed] 28 May 2018
- Glover, D. (2010), *Is Bt Cotton a Pro-Poor Technology? A Review and Critique of the Empirical Record*. Wiley Online Library. <https://onlinelibrary.wiley.com/doi/pdf/10.1111/j.1471-0366.2010.00283.x> [Accessed] 30 May 2018
- Gruere, G. & Sengupta, D. (2011) *Bt cotton and farmer suicides in India: An evidence based assessment*. The Journal of Development Studies, Vol 47, Issue 2 pp 316 – 337. Available <https://www.tandfonline.com/doi/abs/10.1080/00220388.2010.492863> [Accessed] 29 April 2018
- Gruere, G.; Mehta-Bhatt, P. & Sengupta, D. (2011). *Bt Cotton and Farmer Suicides in India Reviewing the Evidence*. IFPRI Discussion Paper 00808. Available [http://www.agrobio.org/bfiles/fckimg/Bt%20cotton%20in%20India%20and%20suicides%20-%20IFPRI%20%202008\(1\).pdf](http://www.agrobio.org/bfiles/fckimg/Bt%20cotton%20in%20India%20and%20suicides%20-%20IFPRI%20%202008(1).pdf) . [Accessed] March 2018
- Esslinger, H. (2011) *Sustainable design: Beyond the innovation-driven business model*. *Journal of Product Innovation Management*, 28(3), 401-404.
- Fletcher, K. (2008), *Sustainable Fashion and Textiles: Design journeys*, London Sterling VA: Earthscan
- Gruere, G. & Sengupta, D. (2011)*Bt cotton and farmer suicides in India: An evidence based assessment*. The Journal of Development Studies, Vol 47, Issue 2 pp 316 – 337. Available <https://www.tandfonline.com/doi/abs/10.1080/00220388.2010.492863> [Accessed] 29April 2018
- Hethorn, J., & Ulasewicz, C. (2008). *Sustainable fashion: Why now?* New York, NY: Fairchild Books
- '*India tops in area under Bt cotton*'. February 19, 2008 [updated October 8, 2016] <http://www.thehindu.com/todays-paper/tp-national/tp-karnataka/India-tops-in-area-under-Bt-cotton/article15169420.ece> [Accessed] 31 May 2018
- Krishnakumar, A. (2005) *Seeds of controversy*. *Frontline*, 22(12). Available at <http://www.hinduonnet.com/fline/fl2212/stories/20050617003010200.htm>. [Accessed 11 April 2018]
- McDonough, W., & Braungart, M. (2002). *Cradle to cradle: Remaking the way we make things*. New York, NY: North Point Press.



Moustakas, C. (1994). *Phenomenological research methods*. Thousand Oaks, CA: Sage

Nadal, A. (2007). *Monsanto, Cereal Killer GM and Agrarian Suicides in India*. La Jornada, 6 January 2007

Papanek, V. (1971). *Design for the Real World: Human ecology and social change*. London, England: Thames & Hudson

Prasad, C. S. (1999). Suicide Deaths and Quality of Indian Cotton: Perspectives from History of Technology and Khadi Movement. *Economic and Political Weekly*, Vol. 34, No. 5 (Jan. 30 - Feb. 5, 1999), pp. PE12 - PE21

Sahai, S. (2005) The Story of Bt Cotton in India. Gene Campaign, November 2005. Available  
<http://www.genecampaign.org/Publication/Pricedpublication/story%20of%20BtCotton.html>. [Accessed 10 April 2018]

Shah, E. (2012) '*A life wasted making dust*': Affective histories of dearth, death, debt and farmers' suicides in India, *The Journal of Peasant Studies*, 39:5, pp1159 – 1179. Available 10.1080/03066150.2011.653344 [Accessed 28 April 2018]

Quinn, B. (2010), *Textile Futures*, Berg Publishers, Oxford: UK

Vasudev. S. (2017), *The Kutch Renaissance*. Livemint Jan 20 2017

**Contact email:** [banhi.jha@nift.ac.in](mailto:banhi.jha@nift.ac.in)



***Theoretical BIM Framework to Sustain the 20th Century Educational Heritage in Bangkok: PNRU Buildings***

Waranyoo Siriwan, Phranakorn Rajabhat University, Thailand  
Kitikorn Makaluk, Phranakorn Rajabhat University, Thailand  
Pornsiri Teerajak, Phranakorn Rajabhat University, Thailand

The Asian Conference on Sustainability, Energy & the Environment 2018  
Official Conference Proceedings

**Abstract**

BIM (Building Information Modelling) implementation to conserve local educational heritages in Bangkok cannot be extensively reached to the dimension of facility management and applications. General BIM framework is not suitable in relation to a heritage project, in particular, bringing the existing AEC (Architecture, Engineering and Construction), social information and the heritage conservation context into BIM process to promote the educational institution management. This paper focuses on theoretical BIM framework to sustain the educational heritages in Bangkok by expanding BIM border to manage efficiently the historic building and sociocultural information in the institution. The research provides a literature review and a qualitative analysis in the BIM theory for Heritage conservation, and the sociocultural information through the institute identity. This research selects the building number 5 and the building number 6 of PNRU (Phranakorn Rajabhat University), which constructed in the early 20th century in Bangkok, as a paradigm to discuss. The result of integrating the heritage building information of both buildings into the single dataset by BIM processing is found that BIM process can be possibly applied for the conservation project modelling and management. The research outcome offers comprehensively theoretical BIM framework being suitable for the educational heritage building for not only conservation but revitalization, correlated community context along a building life cycle.

Keywords: BIM, Heritage, educational, sustainable

**iafor**

The International Academic Forum  
[www.iafor.org](http://www.iafor.org)

## **Introduction**

BIM (Building Information Modeling) operation to conserve many local heritages in Bangkok cannot be extensively reached to the dimension of sustainability through facility management application due to being inapprehensive BIM framework expand to the social context.

BIM used in Thai conservation project reached only at the stage of reproduce construction drawing documentation and three dimension modelling for perspective and animation as CAD and another 3D modelling application do. Most works with BIM are served for new building project but for the field of conservation groups. They prefer CAD to BIM because of being inapprehensive how BIM works in the dimensions of project management. The Technology of BIM is definitely described as a process involving the generation and management of AEC (Architecture Engineering and Construction) in the digital representation formats of physical and functional characteristics of places. (National BIM Standard-United State. 2014.)

## **Issue Statement**

These papers focus on theoretical BIM framework to approach the educational heritage in Bangkok by using BIM as technological assistant to integrate sociocultural information for the heritage evaluation to enhance the existing district identity.

## **Research Methodology**

### **Literature Review in BIM technology, process and output in dimensions.**

The Technology of BIM is definitely described as a process involving the generation and management of AEC (Architecture Engineering and Construction) in the digital representation formats of physical and functional characteristics of places. (National BIM Standard-United State. 2014.) Compare to CAD or hand techniques, BIM is not just a tool. BIM features potentiality can wider expand to the dimension of sustainability such conceptual energy analysis, moreover, the facility management application. It leads to life cycle BIM strategies through future maintenances.

According the process, the benefits of BIM are collaborating between the Facilitates and the disciplines involved in the design, construction, operation and maintenance of existing buildings in the single model, Saving time as the coordination checks and eliminating clash detection, estimating and revising cost, regenerating Building service information for facilities management after completing the project, and quickly transferring between the phases of design, construction and operation. Also during the BIM operation in a building project, the process can be subdivided and coordinated between team members.

The BIM output is beside the 2D documentation, 3D modelling perspective, the plethora of the project information is described in BIM component tables or management schedules. This productivity of BIM technology can be applied with other application such culture social analysis programs. The result of application is used to develop building and facility information to further management.

Generally, BIM strategies is conceptualized in dimensions into the cycle shape. The number of dimensions is considered by the type of project. Of course, BIM life cycle is divided consequently in the 4 main performances as above by containing at least seven dimensions along a project. Inside the project loop of BIM related to previous 4 performances is divided into seven dimensions. It starts from the first dimension reviewing existing site analysis, building regulation, basic design concept and BIM software. The Second and Third dimension present Design drawing in a flat image, three-dimensional Model with building parameters, the project Animation and building documentation.

Fourth Dimension (4D) covers the aspect of phasing and sequencing to the project. There work in 3-dimension virtual model linking to construction cost estimation and a time schedule. Fifth Dimension (5D) is used as complete building system related to construction cost and project management from the previous dimensions consideration.

Sixth dimension or 6D is focus on the building life cycle managing and maintaining the building and its facilities that result from second-to-fifth Dimensions. However, there magnify the outcome from 6 dimensions to the superior dimension that expect the building future as sustainable. Besides the 6 dimensions, BIM is expandable to  $x^{\text{th}}$  dimension (number 7 or more) that collaborate between building information and another technologies.

### **BIM Theoretical framework for the heritage building (HBIM).**

Initially, BIM is designed to support AEC industry whether to construct new buildings or to renovate old ones. Later BIM is developed in working dimensions to manage and prolong existing buildings look new along the building life cycle. From its dimensional feature, BIM is taken advantages in a conservation project of historic buildings. HBIM (Heritage Building Information Modelling) has the different framework in some detailing stages and scope. It includes added educational functions and the process of building construction replaced by renovation.

As a result, the following HBIM process is adapted in some details related to heritage conservation process for sustainable building. The HBIM is preferable the term of reproduction and conservation to the complete new building. According to the process concept to create the building, the process is divided in 4 stages: In the complex conservation concept of HBIM, the stage “Design” is replaced by “Building surveying”. And the stage of construction is placed by “Renovation”. In additional, one of challenges in BIM is integrating with other technologies to share data between two technology platforms in an AEC industry, service market and social survey technology by offering BIM new tool or plug-in to help exporting data to other programs along the BIM life cycle (Figure 1).

For an example, the drawing file (\*.dwg) is exported by BIM to other technologies to analysis in ecological, energy use and social media to apply for sustainable building management.

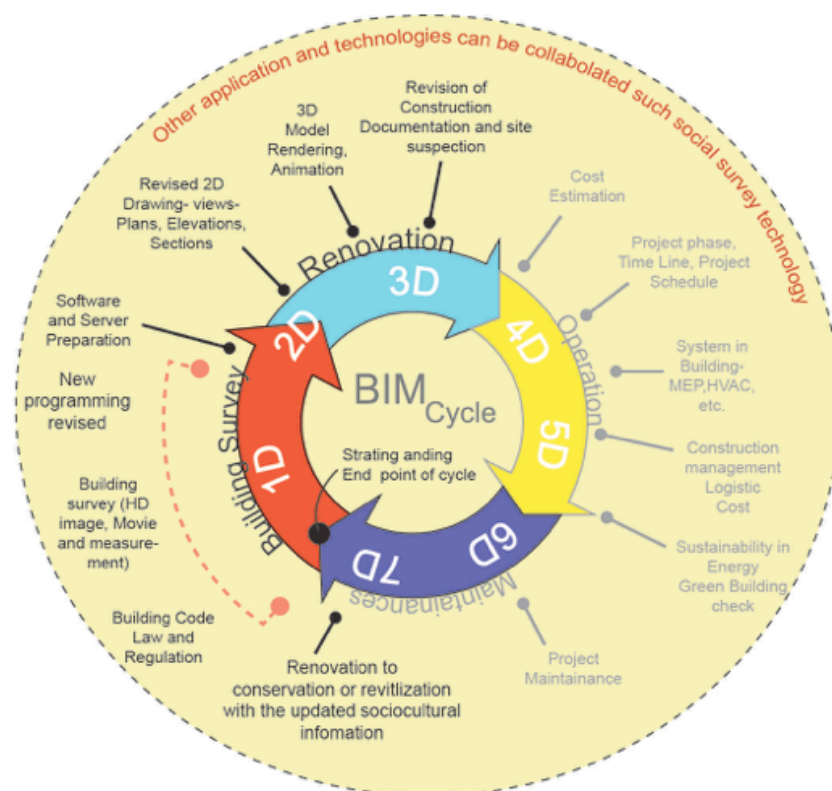

Figure 1: Adapted diagram of HBIM from BIM life cycle.

### DATA - Case study: Building 5-6, PNRU, Bangkok.

PNRU (Phranakorn Rajabhat University) is the first Teaching College in Thailand which is established from King Rama V in the name "Teaching School" since 1892 till 1956 (Figure 2).

Originally, PNRU mission statement is to offer academic service and technology, to conserve and develop including to serve the art & cultural information center for the local community. One of distinctive heritage is the building 5 and 6 where functions as laboratories, class rooms, academic staff workplaces and a library of Faculty of Humanity Social Science. From the recent survey in the sociocultural part, it found that building can contain 470 students and 50 academic staffs. Most classroom is adapted from general class rooms into the studio.

Building 5 and 6 are the couple of two-story reinforced concrete building built in the early 20<sup>th</sup> century with modern architecture style. The total function areas of building 5 and 6 are 1380, 1410 square meters consequently. The whole structural materials of both buildings is made of reinforced concrete. The primary structural system is beams and columns designed in a concrete frame structure. The noticeable element of buildings which people can see are vertical-and-horizontal concrete sunshades and gable roofs. In the part of interior architectural material use teak for floor planks, doors and windows (Figure 3). The first floor is the laboratories and class rooms, the upper floors is consisted of 9 lecture rooms and a restroom for each story. Its corridor is constructed in the single corridor filled the sense of Thai modern designed to engage people to remedy the past history of buildings.

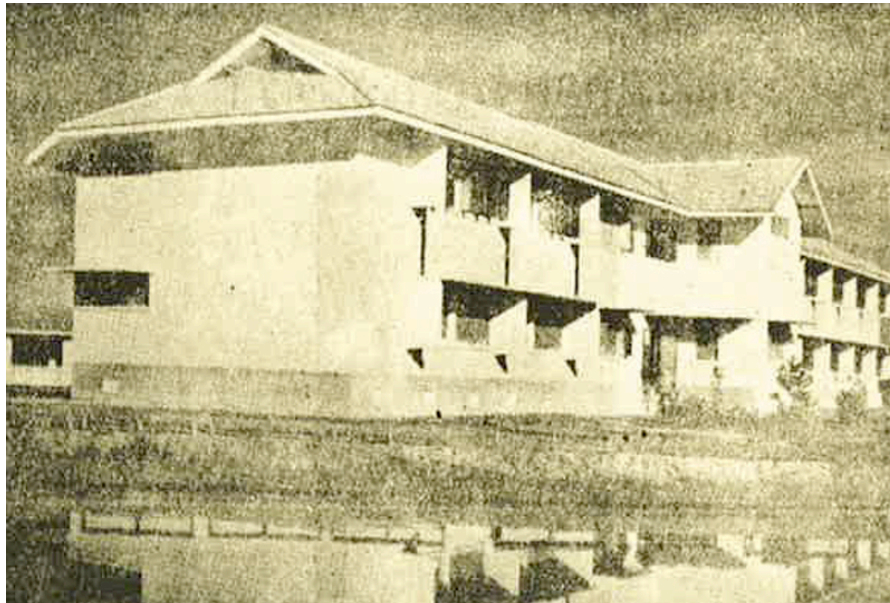

Figure 2: Building No. 6 in the past. (Pranakorn Rajabhat University. ny.)



Figure 3: Digital Photo of Building at the interior and frontal view.

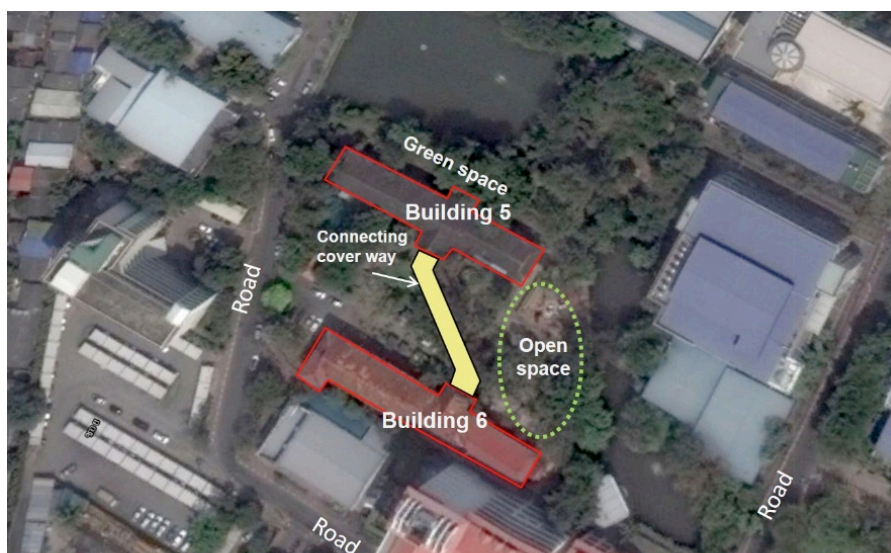

Figure 4: Overview of Building No.5 and 6

## Analysis and Result

### **BIM in Physical and Social-Cultural part to Building conservation.**

To achieve all data aspects, the research methodology for heritage building are classified in 2 parts to search the actual research requirement and then arranged in step by step: Physical and Social-Cultural. The Physical part contains in AEC (Architecture Engineering, Construction) industry, facilities management, at the same time, the social-culture part covers in historical background of buildings and current building users along their educational community in PNRU. The data of both parts is separated in 3 consequently working levels (Figure 5).

Preliminary data is collected to review in the existing physical building condition- HD images from the past, old architectural model, existing construction documentation, Drawing reproduction and combined media such photo montage. Also it collects image of people using a building, inclusive of phenomena and memo written in building all days from surveyors. Secondary data stage is continuous from the previous data collection in the existing evidences of the building, examples for drawing documentation, inclusive of new photography and video recording. The secondary data is regenerated revised and summarized to be easily understood such graphic, photo montages, diagrams or tables.

During the process of Regeneration and DATA Analysis is processed by BIM Technology. This stage BIM integrates secondary data in a single set of data and differentiates the big one set in many dimensional model along the building life cycle. BIM presented all data and analysis it in the single set of the data. The one is composed of Physical finding building parameter. This finding, basically is to help revising building Data during the building life cycle to renovate the heritage building (Figure 6).

In this stage, several software products are developed to fulfill BIM Technology in the additional tool such as Plug-in, add-on or extra building components. These products



are created by software developers companies which always communicate commercial BIM software or networks.

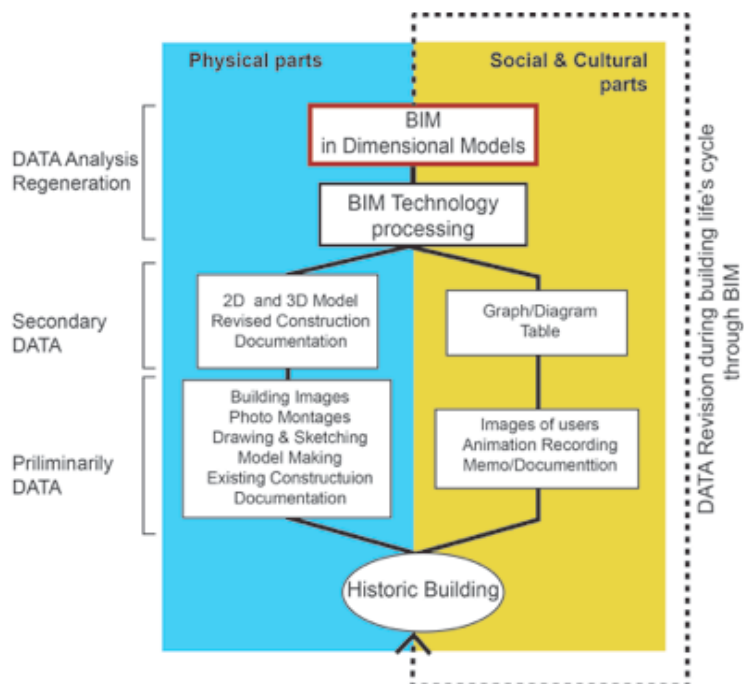

Figure 5: Flow Chart of DATA Collecting to BIM processing in the heritage building.

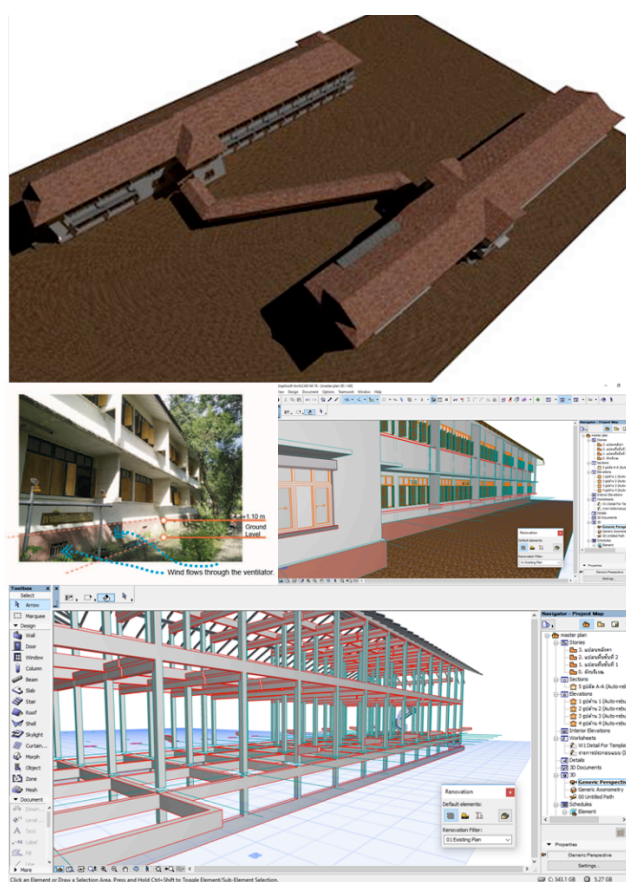

Figure 6: A sample of the BIM DATA analysis regeneration in ACE for the heritage.

### **Dimensional Model in BIM for sustainable conservation.**

Referred to the PNRU site, BIM framework is assigned in the stage of analysis and regeneration before BIM is sustained for the heritage building conservation in the educational community. Beyond the character of AEC, Building number 5 and 6 contain the context of social activities from users: professors and their students, academic staff, visitors, later, taken to investigate and be analyzed in BIM process.

Preliminary, the first dimension of BIM (2D) is the reproduction of heritage building by revising old-new physical information to updated construction drawing and documentation in latest version, then the rendered model and animation is regenerated in 3 dimension of BIM. BIM output in both parts are result like CAD software do, but BIM does in one stop, while CAD need a set of the software combination, such as AutoCAD, Photoshop and SketchUP. BIM in 2D presents drawing in flatten, photo montages and documentation and 3D show rendered three-dimensioned model.

Furthermore, BIM processing is not limited only at two-dimension or three-dimension, but forth to seventh or beyond dimensions. The Forth-dimension (4D) presents the 3D virtual construction model been cumulative from the 3D model by incorporating the renovated documentation in AEC and Project planning with working schedules to manage, revise conflicted documentation. The model of fifth dimension integrates cost estimation and project revision, time management through the previous information model.

The utilization for 6D modelling is approached to the sustainability in building elements and AEC system. The term of sustainability also covers energy management in the building. And the seventh dimension modelling is to utilize the building maintenance along its life cycle. In the x dimension model , the potential BIM platform allow users to integrate with changes of other sociocultural technology advances such social network, cloud technology. The result dissolves the boundary between BIM and social context and heritage building to redefine the relationship between the heritage conservation to the educational community context.

In case of the outcomes and participations to PNRU community, BIM are redefined in Table 1. The final outcomes between PNRU participation and the heritage building are opened by taking a big set of the single data in the dimension at X. These set can be outputted to another field of Technologies, in particular social technology referred to past statistic, for examples, space syntax software used a tool to analysis for fundamental understanding of the relationship between spatial design and the use of space as well as longer term social outcomes. The data output is reapplied to manage building during its life cycle.

Table 1: Summary of BIM dimension related to be beneficial to PNRU community.

<b>BIM DIMENSION</b>	<b>OUTPUT</b>	<b>OUTCOME</b>	<b>BENECIAL PARTICIPATION TO PNRU</b>
<b>2D</b>	Existing renovated construction Drawing	and Full-survey in the heritage building.	-

<b>BIM DIMENSION</b>	<b>OUTPUT</b>	<b>OUTCOME</b>	<b>BENEFICIAL PARTICIPATION TO PNRU</b>
	(AEC) High-definition Image	Understand the building and users behavior in Bldg.5-6	Can be recorded as the case study for other buildings.
	Photo montage	The overview relationship between construction of built-in documentation and the actual situation in building.	See the existing indoor and outdoor environmental quality.
<b>3D</b>	3d model and Visualization Animation with 2D and 3D documentations.	The image of Reality (As-renovated)	Understanding the educational space in Building 5-6.
	Point cloud from 3D scanner concerned.		-
	ACE modelling	Clash analysis in AEC industry with precision and accuracy in measurement. The drawings become as Approved for release to use not as Principle.	-
<b>4D</b>	3D virtual model	-	
	As-built Construction Documentation	-	PNRU can revise detail before approval.
	Project Planning and Schedule.	Planning project and its time schedule before beginning construction.	Convenient to PNRU in financial and time management. Plan to provide the area and to move building users (students and staffs) to another place.
<b>5D</b>	3D Virtual model	-	-
	BOQ (Bill of Quantity)	Construction cost table Estimated from the 4D BIM helps to control budget before starting building.	Budget revision and Confirmation.
	Table of Project management	Able to revise and manage project to solute in conflict	Reduce budget in construction.

<b>BIM DIMENSION</b>	<b>OUTPUT</b>	<b>OUTCOME</b>	<b>BENEFICIAL PARTICIPATION TO PNRU</b>
<b>6D</b>	Model of Designs, components inserted building to develop to sustainable design project.	documentation. Sustainable design	Sustainable Facilities for PNRU community.
	Model of energy consumption, saving and conservation in Building to manage as efficiency.	Possible Energy management	Saving electricity, water consumption cost Realized to re-used energy for building.
<b>7D</b>	Model of all building components that can be inspected to repair or replaced as necessarily.	Maintenance through the building life cycle.	Maintain the heritage building and add value by BIM.
<b>HIGHER THAN 7D (XD)</b>	BIM Model can access to other sociocultural information.	The data in BIM is shared other technologies. The result shows in graphic and non-graphic.	The finding of PNRU Contextual identity, Its sociocultural information which can be applied for other technologies.

### **BIM to PNRU Identity**

The approach to the PNRU Identity is necessarily investigated the main mission of PNRU establishment. Its identity is presented through the building and users' activity. BIM offers the method in heritage conservation and development, social-and-cultural knowledge center by collecting data (Figure 7).

At present the mission is still incomplete because the university itself cannot show as the historic conservative center. So, to achieve the mission, the one solution can practice is that the institution must be clarify its outstanding identity by refurbishing image pass through the building.

Here BIM play the important role in PNRU as the negotiator between the heritage conservation with identity and the new trend of educational community to the sustainable heritage educational building (Figure 8).

The changed building will invite people in site participating in PNRU community activity by adapting the indoor space more welcome.

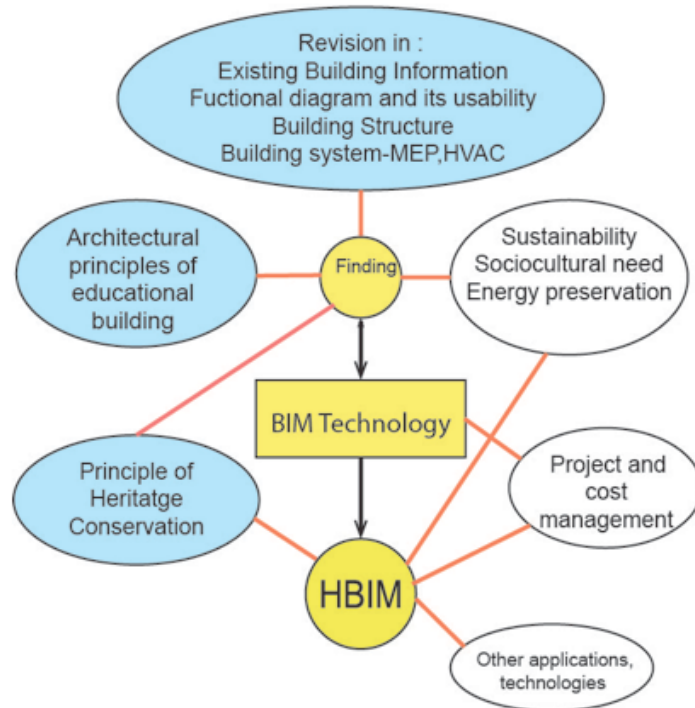
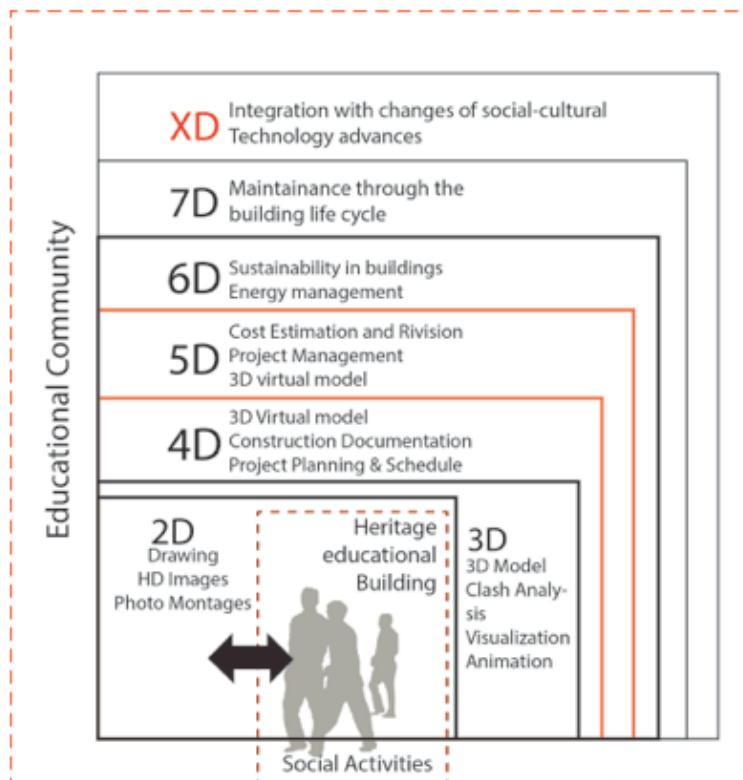

Figure 7: DATA Collecting to BIM processing in the educational heritage model.



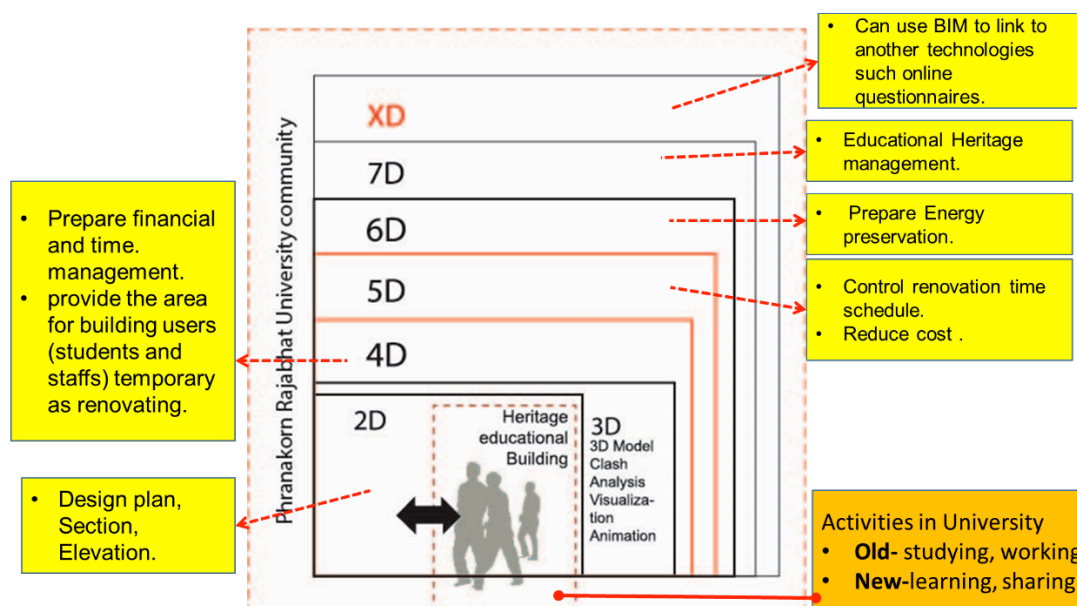

Figure 8: Analysis theoretical relationship between BIM dimensions in the educational heritage and its sustaining process.

### Conclusion and Future work

Following the result, HBIM (Building Information Modeling) Framework in Theory is able not only to guide restoring Heritage building in conservation theme, but sustain for educational heritage realize that AEC, social activity and conservation along building's life cycle. HBIM potential can integrate all to approach to the educational community (Figure 7).

Figure 8 shows the theoretical relationship diagram between BIM dimensions in the educational heritage. Also this diagram can be substituted by the case study Phranakorn Rajabhat University information to sustain. The result is possibly sustained for conservation but revitalization to prepare for a sustainable heritage correlated community context along a building life cycle.

In the future work, after discovering these finding, the heritage building can be revitalized in the next steps by using BIM platform and its tool to develop heritage buildings as sustainable.

## References

- A. L. C. Ciribini, S. Mastrolembo Ventura & M. Paneroni. (2015). BIM methodology as an integrated approach to heritage conservation management. *Building Information Modelling (BIM) in Design, Construction and Operation*, 149, 265-276.
- Erika Johansson, Darek M. Haftor, Bengt Magnusson, Jan Rosvall. (2014). *Use of BIM for existing Buildings*. [Online]. Netherland: Linnaeus University Press.
- Garagnani, S., Manfredini, A. M. (2013). Parametric Accuracy: Building Information Modeling Process Applied to the Cultural Heritage Preservation, 4th ISPRS International Workshop “3D-ARCH”, Trento, Italy.
- Hung-Ming Cheng, Wun-Bin Yang, Ya-Ning Yen. (2015). BIM applied in historical building documentation and refurbishing. The International Archives of the Photogrammetry, *Remote Sensing and Spatial Information Sciences*, Volume XL-5/W7, 2015 25th International CIPA Symposium 2015, 31 August – 04 September 2015, Taipei, Taiwan.
- James Maddigan. (2012). BIM and Heritage Conservation. HCF National Heritage Summit, October 11-13, 2012.
- Laila M. Khodeir, Dalia Aly, Shaimaa Tarek. (2016). Integrating HBIM (Heritage Building Information Modeling) Tools in the Application of Sustainable Retrofitting of Heritage Buildings in Egypt. *Procedia Environmental Science*, 34, 258 – 270.
- Naglaa A. Megahed. (2015). Toward A Theoretical Framework for HBIM Approach in Historic Preservation and Management. *Archnet-IJAR*, Vol. 9(3), November 2015, 130-147.
- Sebastiano Maltese, Lavinia C. Tagliabue, Fulvio Re Cecconia, Daniela Pasinia, Massimiliano Manfren, Angelo L.C. Ciribini. (2017). Sustainability assessment through green BIM for environmental, social and economic efficiency. *Procedia Engineering*, 180, 520 – 530.
- S. Logothetis, A. Delinasiou, E. Stylianidis. (2015). Building Information Modelling for Cultural Heritage: a review. *ISPRS Annals of the Photogrammetry, Remote Sensing and Spatial Information Sciences*, Volume II-5/W3, 25th International CIPA Symposium 2015, 31 August – 04 September 2015, Taipei, Taiwan.
- Volk, R., Stengel, J., Schultmann, F. (2014): Building Information Models (BIM) for existing buildings – literature review and future needs. *Automation in Construction*. 38, 109-127.
- Y. P. MA1, M. C. LIN, C. C. HSU. (2016). Enhance Architectural Heritage Conservation Using BIM Technology. *Living Systems and Micro-Utopias: Towards Continuous Designing*, Proceedings of the 21st International Conference of the Association for Computer-Aided Architectural Design Research in Asia CAADRIA 2016, 477–486.

Hannele K1, Reijo M, Tarja M, Sami P, Jenni K, Teija R. 2012. Expanding uses of building information modeling in life-cycle construction projects. *Work*. 2012; 41 Suppl 1:114-9. DOI= 10.3233/WOR-2012-0144-114.

**Contact email:** waranyoo@pnru.ac.th







©The International Academic Forum 2018  
The International Academic Forum (IAFOR)  
Sakae 1-16-26-201  
Naka Ward, Nagoya, Aichi  
Japan 460-0008  
[www.iafor.org](http://www.iafor.org)